



## 產品說明

### MASTERColour CDM-Rm Mini Elite 小型陶瓷複金屬燈

輕鬆呈現更多閃耀效果。新型飛利浦 MASTERColour CDM-R Mini 將深獲肯定的 MASTERColour 品質導入 50 公釐反光罩燈管，具備卓越的輸出和色彩穩定性，能營造適當氣氛，因應客戶的零售品牌和定位需求

#### 优点

- 微型化的 50 公釐 CDM 反光罩燈管，能採用最精巧的小燈具，同時確保天花板美觀不擁擠
- 適用於開放式燈具，易於安裝及維護
- 相較於低電壓鹵素燈，可節省最高 60% 的能源。熱輸出相當低
- 本款燈管提供清澈的白色燈光，以及優異的色彩穩定性

#### 特点

- 微型化的 50 公釐 CDM 反光罩燈管
- 光束强度高
- 燈管使用壽命長，超越鹵素燈
- 轉鎖式系統

#### 应用

- 微型化的清澈白色燈光系統，在商店內提供卓越的重點及一般照明

#### 安全提示

- Use only with electronic control gear
- Control gear must include end-of-life protection (IEC61167, IEC 62035).
- A lamp breaking is extremely unlikely to have any impact on your health. If a lamp breaks, ventilate the room for 30 minutes and remove the parts, preferably with gloves. Put them in a sealed plastic bag and take it to your local waste facilities for recycling. Do not use a vacuum cleaner.

# MASTERColour CDM-Rm Mini Elite 小型陶瓷複金屬燈

## 二维绘图

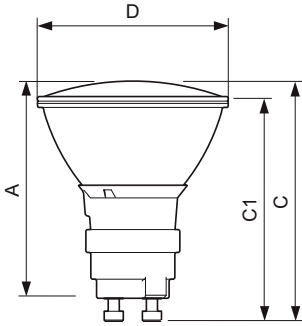

Product	D (max)	D	C (max)	C	C1 (max)	A (max)
CDM-Rm Elite Mini 20W/830 GX10 MR16 10D	51 mm	50 mm	65.4 mm	62.75 mm	60.9 mm	59 mm
CDM-Rm Elite Mini 20W/830 GX10 MR16 25D	51 mm	50 mm	65.4 mm	62.75 mm	60.9 mm	59 mm
CDM-Rm Elite Mini 20W/830 GX10 MR16 40D	51 mm	50 mm	65.4 mm	62.75 mm	60.9 mm	59 mm
CDM-Rm Elite Mini 35W/930 GX10 MR16 10D	51 mm	50 mm	65.4 mm	62.75 mm	60.9 mm	59 mm
CDM-Rm Elite Mini 35W/930 GX10 MR16 25D	51 mm	50 mm	65.4 mm	62.75 mm	60.9 mm	59 mm
CDM-Rm Elite Mini 35W/930 GX10 MR16 40D	51 mm	50 mm	65.4 mm	62.75 mm	60.9 mm	59 mm

一般資訊	
燈座基底	GX10
切換週期	1,350
操作位置	UNIVERSAL
照明技術	
色度坐標 X (標稱)	0.434
色度坐標 Y (Nom)	0.398
相關色彩溫度 (規範)	3000 K
運轉與電力	
達到 60% 光色的熱機時間	120 s
控制與調光	
可調光	否
機械與外罩	
燈泡形狀	MR16

## 照明技術 (1/2)

Order Code	Full Product Name	光束角 (Nom)	演色性指數 (CRI)	LLMF 標稱壽命 結束 (規範)	光效 (額定) (標準)
928191005331	CDM-Rm Elite Mini 20W/830 GX10 MR16 10D	10 °	84	70 %	49 lm/W
928191105331	CDM-Rm Elite Mini 20W/830 GX10 MR16 25D	25 °	84	70 %	50 lm/W
928191205331	CDM-Rm Elite Mini 20W/830 GX10 MR16 40D	40 °	84	70 %	50 lm/W
928194605330	CDM-Rm Elite Mini 35W/930 GX10 MR16 10D	10 °	90	80 %	60 lm/W
928194705330	CDM-Rm Elite Mini 35W/930 GX10 MR16 25D	25 °	90	80 %	60 lm/W
928194805330	CDM-Rm Elite Mini 35W/930 GX10 MR16 40D	40 °	90	80 %	61 lm/W

## 照明技術 (2/2)

Order Code	Full Product Name	光通量	光強 (標稱)	Order Code	Full Product Name	光通量	光強 (標稱)
928191005331	CDM-Rm Elite Mini 20W/830 GX10 MR16 10D	880 lm	14,500 cd	928194605330	CDM-Rm Elite Mini 35W/930 GX10 MR16 10D	2,100 lm	17,500 cd
928191105331	CDM-Rm Elite Mini 20W/830 GX10 MR16 25D	900 lm	4,000 cd	928194705330	CDM-Rm Elite Mini 35W/930 GX10 MR16 25D	2,150 lm	7,600 cd
928191205331	CDM-Rm Elite Mini 20W/830 GX10 MR16 40D	860 lm	1,750 cd	928194805330	CDM-Rm Elite Mini 35W/930 GX10 MR16 40D	2,150 lm	3,600 cd

## 運轉與電力

Order Code	Full Product Name	電壓 (標稱)	耗電量	Order Code	Full Product Name	電壓 (標稱)	耗電量
928191005331	CDM-Rm Elite Mini 20W/830 GX10 MR16 10D	95 V	20.1 W	928194605330	CDM-Rm Elite Mini 35W/930 GX10 MR16 10D	87 V	39.1 W
928191105331	CDM-Rm Elite Mini 20W/830 GX10 MR16 25D	95 V	20.1 W	928194705330	CDM-Rm Elite Mini 35W/930 GX10 MR16 25D	87 V	39.1 W
928191205331	CDM-Rm Elite Mini 20W/830 GX10 MR16 40D	95 V	20.1 W	928194805330	CDM-Rm Elite Mini 35W/930 GX10 MR16 40D	87 V	39.1 W

## 認證與應用

# MASTERColour CDM-Rm Mini Elite 小型陶瓷複金屬燈

Order Code	Full Product Name	能源消耗 kWh/1000 h	汞 (Hg) 含 量 (最大)	汞 (Hg) 含 量 (標稱)
928191005331	CDM-Rm Elite Mini 20W/830 GX10 MR16 10D	21 kWh	3.5 mg	3.5 mg
928191105331	CDM-Rm Elite Mini 20W/830 GX10 MR16 25D	21 kWh	3.5 mg	3.5 mg
928191205331	CDM-Rm Elite Mini 20W/830 GX10 MR16 40D	21 kWh	3.5 mg	3.5 mg
928194605330	CDM-Rm Elite Mini 35W/930 GX10 MR16 10D	40 kWh	4.7 mg	4.7 mg
928194705330	CDM-Rm Elite Mini 35W/930 GX10 MR16 25D	40 kWh	4.7 mg	4.7 mg
928194805330	CDM-Rm Elite Mini 35W/930 GX10 MR16 40D	40 kWh	4.7 mg	4.7 mg

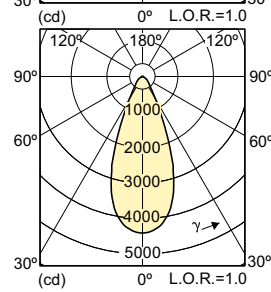
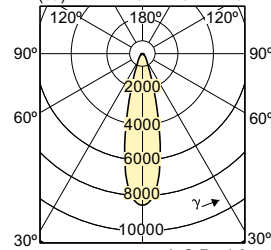
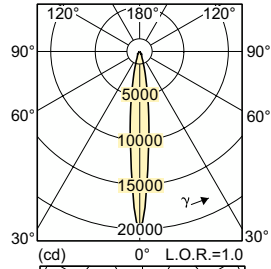
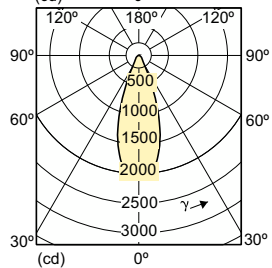
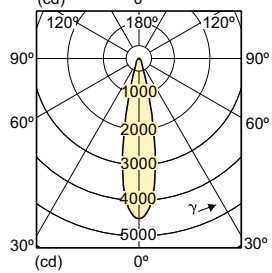
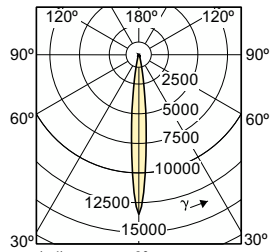

# MASTERColour CDM-Rm Mini Elite 小型陶瓷複金屬燈

## Accent Diagrams

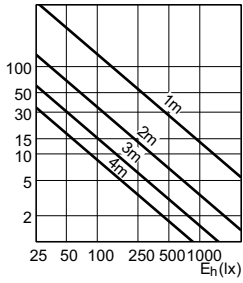

Accent Diagram - CDM-Rm Elite Mini 20W/830  
GX10 MR16 10D

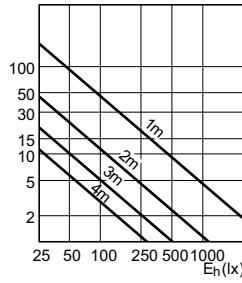

Accent Diagram - CDM-Rm Elite Mini 20W/830  
GX10 MR16 25D

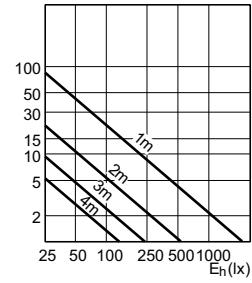

Accent Diagram - CDM-Rm Elite Mini 20W/830  
GX10 MR16 40D

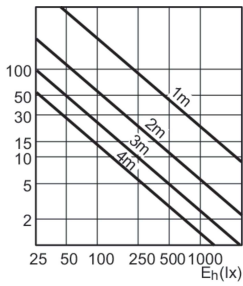

Accent Diagram - CDM-Rm Elite Mini 35W/930  
GX10 MR16 10D

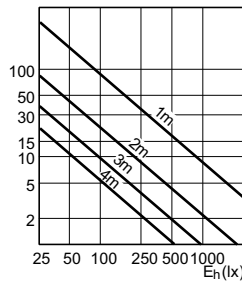

Accent Diagram - CDM-Rm Elite Mini 35W/930  
GX10 MR16 25D

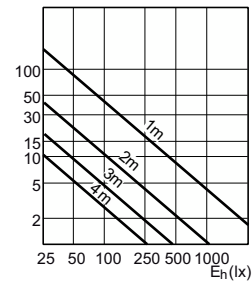

Accent Diagram - CDM-Rm Elite Mini 35W/930  
GX10 MR16 40D

## Beam Diagrams

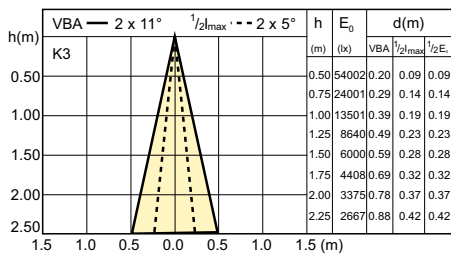

Beam diagram - CDM-Rm Elite Mini 20W/830  
GX10 MR16 10D

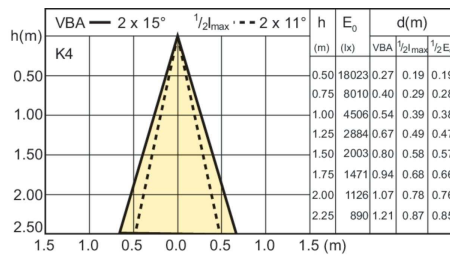

Beam diagram - CDM-Rm Elite Mini 20W/830  
GX10 MR16 25D

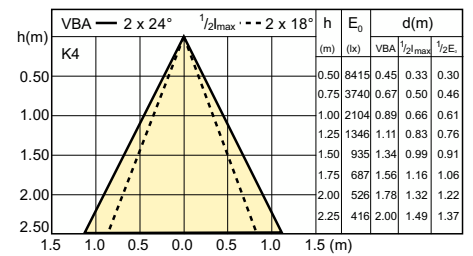

Beam diagram - CDM-Rm Elite Mini 20W/830  
GX10 MR16 40D

# MASTERColour CDM-Rm Mini Elite 小型陶瓷複金屬燈

## Beam Diagrams

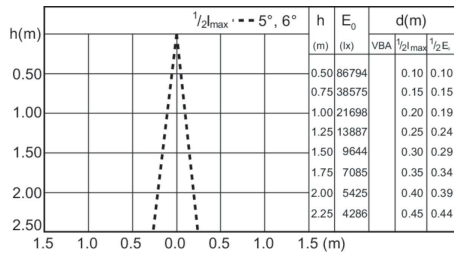

Beam diagram - CDM-Rm Elite Mini 35W/930  
GX10 MR16 10D

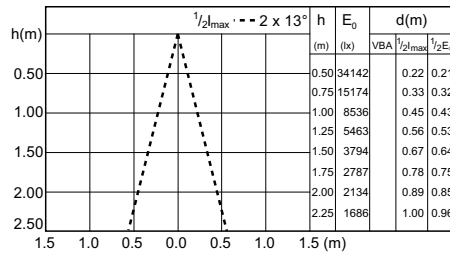

Beam diagram - CDM-Rm Elite Mini 35W/930  
GX10 MR16 25D

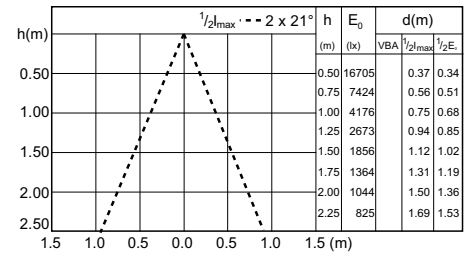

Beam diagram - CDM-Rm Elite Mini 35W/930  
GX10 MR16 40D

