



Product Description

PAR38

Pressed-glass 121 mm diameter reflector lamps of high luminous intensity

Benefits

- Produces the same useful light as conventional PAR lamps at 20% lower energy

Features

- Spot versions have a stippled front reflector producing a narrow, homogeneous beam
- Flood versions have a front refractor composed of prismatic elements

Application

- Can be used indoors and outdoors, or wherever blown-bulb reflector lamps would be too vulnerable
- Indoors: shops, window displays, homes, hotels, restaurants, theatres, museums, exhibitions and buildings
- Outdoors: floodlighting, advertising signs, buildings, statues, podiums, sports grounds, parks and gardens
- Can be installed outdoors without any protection, provided they are used in a watertight lampholder
- For outdoor use, a heat-resistant rubber ring must be fitted between the lamp and the lampholder

PAR38

Versions



LPPR IPAR38-E E27 E2751 FL

Dimensional drawing

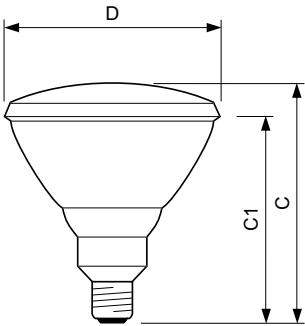

Product	D (max)	C (max)	
PAR38 120W E27/51 220-240V PAR38 30D 1CT	121 mm	137 mm	123 mm
PAR38 80W E27 230V PAR38 FL 30D 1CT/12	123 mm	137 mm	

General Information

Rated Lifetime (Hours)	2,000 hour(s)
Nominal lifetime	2,000 hour(s)
Operating Position	UNIVERSAL

Light Technical

Beam Angle (Nom)	30 degree(s)
Color rendering index (CRI)	100

Operating and Electrical

Starting Time (Nom)	0.0 s
---------------------	-------

Mechanical and Housing

Bulb Shape	PAR38
------------	-------

General Information

Order Code	Full Product Name	Cap-Base	Switching Cycle
923810544296	PAR38 80W E27 230V PAR38 FL 30D 1CT/12	E27	8,000

Order Code	Full Product Name	Cap-Base	Switching Cycle
923815643301	PAR38 120W E27/51 220-240V PAR38 30D 1CT	E27/51	-

Light Technical

PAR38

Order Code	Full Product Name	Correlated Color	
		Temperature (Nom)	Luminous Flux
923810544296	PAR38 80W E27 230V PAR38 FL 30D 1CT/12	2700 K	-

Order Code	Full Product Name	Correlated Color	
		Temperature (Nom)	Luminous Flux
923815643301	PAR38 120W E27/51 220-240V PAR38 30D 1CT	-	1,150 lm

Operating and Electrical

Order Code	Full Product Name	Warm-up time to 60% light	Voltage (Nom)	Power Consumption
923815643301	PAR38 120W E27/51 220-240V PAR38 30D 1CT	-	220-240 V	120 W

Controls and Dimming

Order Code	Full Product Name	Dimmable
923810544296	PAR38 80W E27 230V PAR38 FL 30D 1CT/12	Yes

Order Code	Full Product Name	Dimmable
923815643301	PAR38 120W E27/51 220-240V PAR38 30D 1CT	-

Approval and Application

Order Code	Full Product Name	Energy Consumption kWh/1000 h
923810544296	PAR38 80W E27 230V PAR38 FL 30D 1CT/12	80 kWh
923815643301	PAR38 120W E27/51 220-240V PAR38 30D 1CT	-

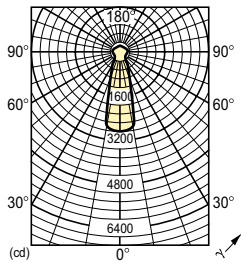
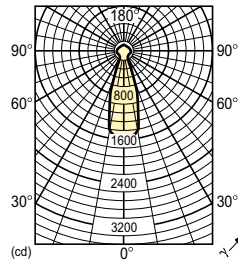

PAR38

Accent Diagrams

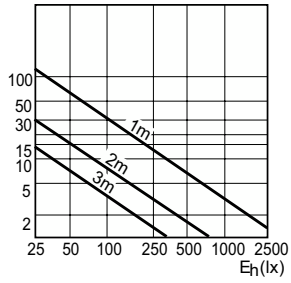

Accent Diagram - PAR38 120W E27/51
220-240V PAR38 30D 1CT

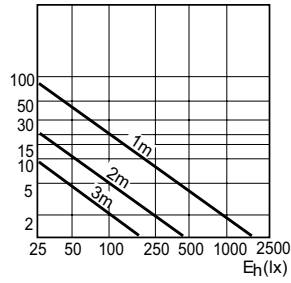

Accent Diagram - PAR38 80W E27 230V PAR38
FL 30D 1CT/12

Beam Diagrams

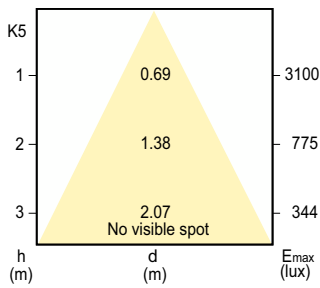

Beam diagram - PAR38 120W E27/51 220-240V
PAR38 30D 1CT

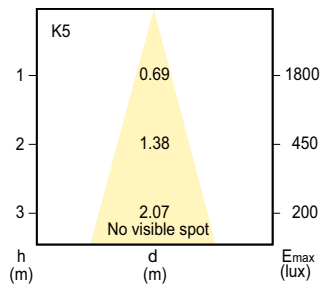

Beam diagram - PAR38 80W E27 230V PAR38
FL 30D 1CT/12

