



GreenSpace Surface-mounted

SM291C LED10/865 PSU WH GM

GreenSpace Surface-mounted, 10 W, 1000 lm, 6500 K, High-gloss mirror, Finger-protected

Philips GreenSpace Surface-mounted LED Downlight delivers a superior LED alternative that's up to 66% more energy efficient than the conventional downlight retrofits. Blending seamlessly into its environment, GreenSpace Surface-mounted LED Downlight mimics the form of conventional recessed downlights minus the associated high energy and maintenance costs. Philips GreenSpace Surface-mounted LED Downlight is also ideal for all commercial lighting applications as well as public indoor space where there is limited space in the ceiling.

Product data

General Information	
Light source replaceable	No
Number of gear units	1 unit
Driver included	Yes
Light source engine type	LED
Service tag	Yes
CE mark	CE mark
Warranty period	3 years
Flammability mark	-
ENEC mark	-
Glow-wire test	Temperature 750 °C, duration 5 s
EU RoHS compliant	No

Light Technical	
Luminous Flux	1,000 lm
Correlated Color Temperature (Nom)	6500 K
Luminous Efficacy (rated) (Nom)	100 lm/W
Color rendering index (CRI)	>80
Beam angle of light source	- degree(s)
Light source color	865 cool daylight
Optic type	High-gloss mirror
Optical cover type	Reflector
Luminaire light beam spread	90°

Operating and Electrical	
Input Voltage	220 to 240 V
Line Frequency	50 or 60 Hz

GreenSpace Surface-mounted

Inrush current	11 A
Inrush time	0.003 ms
Power Consumption	10 W
Power Factor (Fraction)	0.9
Connection	-
Cable	-
Number of products on MCB of 16 A type B	30

Temperature

Ambient temperature range	-20 to +40 °C
---------------------------	---------------

Controls and Dimming

Dimmable	No
Driver/power unit/transformer	Power supply unit (On/Off)
Control interface	-
Constant light output	No

Mechanical and Housing

Housing Material	Aluminum die cast
Reflector material	Aluminum
Optic material	Aluminum
Optical cover material	-
Fixation material	-
Housing Color	White
Optical cover finish	-
Overall length	0 mm
Overall width	0 mm
Overall height	135 mm
Overall diameter	160 mm
Dimensions (Height x Width x Depth)	135 x 0 x 0 mm

Approval and Application

Ingress protection code	IP20 [Finger-protected]
Mech. impact protection code	IK02 [0.2 J standard]
Protection class IEC	Safety class I

Initial Performance (IEC Compliant)

Luminous flux tolerance	+/-10%
Initial chromaticity	(0.31, 0.32) SDCM <5
Power consumption tolerance	+/-10%

Over Time Performance (IEC Compliant)

Driver failure rate at 5000 h	1.00 %
Median useful life L70B50	50,000 hour(s)
Median useful life L80B50	40,000 hour(s)
Median useful life L90B50	20,000 hour(s)

Application Conditions

Suitable for random switching	No
-------------------------------	----

Product Data

Order product name	SM291C LED10/865 PSU WH GM
Full product name	SM291C LED10/865 PSU WH GM
Full product code	872016972369600
Order code	72369600
Material Nr. (12NC)	911401847399
Numerator - Quantity Per Pack	1
EAN/UPC - Product/Case	8720169723696
Numerator - Packs per outer box	1
EAN/UPC - Case	8720169723696

Dimensional drawing

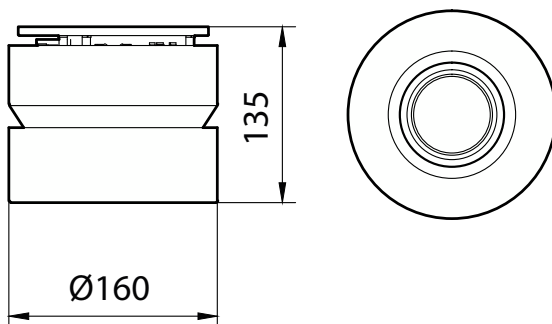

GreenSpace Surface-mounted

