

HF-Performer TL5 Circular

HF-P 155 TL5C 220-240V 50/60HZ

Compact, square, lightweight, High Frequency electronic ballasts for TL5 Circular lamps

Product data

Operating and Electrical	
Input Voltage	220 to 240 V
Line Frequency	50 to 60 Hz
Input Frequency	50 to 60 Hz
Inrush Current Width	0.17 ms
Inrush Current Peak (Max)	20 A
Number of Products on MCB (16A Type B) (Nom)	28
Wiring	
Connector Type Input Terminals	Insert
Connector Type Output Terminals	Insert
Temperature	
Ambient temperature range	-20 °C to 50 °C
T-Case Lifetime (Nom)	70 °C
T-Case Maximum (Max)	70 °C
Mechanical and Housing	
Housing	S 103x67x30

Approval and Application	
Energy Efficiency Index	A3
Safety Standard	IEC 61347-2-3
Environmental Standard	ISO 14001
Approval Marks	CE marking ENEC certificate VDE-EMV certificate
Product Data	
Order product name	HF-P 155 TL5C 220-240V 50/60Hz
Full product name	HF-P 155 TL5C 220-240V 50/60Hz
Full product code	871150092776730
Order code	92776730
Material Nr. (12NC)	913700163891
Numerator - Quantity Per Pack	1
EAN/UPC - Product/Case	8711500927767
Numerator - Packs per outer box	36
EAN/UPC - Case	8711500927774

HF-Performer TL5 Circular

Dimensional drawing

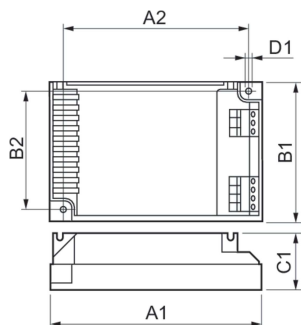

Product	D1	C1	A1	A2	B1	B2
HF-P 155 TL5C 220-240V 50/60Hz	4.5 mm	30.0 mm	103.0 mm	93.5 mm	67.0 mm	57.5 mm

