

HF-Performer TL5 Circular

HF-P 160 TL5C 220-240V 50/60HZ

Compact, square, lightweight, High Frequency electronic ballasts for TL5 Circular lamps

Product data

Operating and Electrical	
Input Voltage	220 to 240 V
Line Frequency	50 to 60 Hz
Input frequency	50 to 60 Hz
Inrush current width	0.17 ms
Inrush current peak (max.)	20 A
Number of products on MCB (16 A type B) (nom.)	28
Wiring	
Connector type input terminals	Insert
Connector type output terminals	Insert
Temperature	
Ambient temperature range	-20°C to 60°C
T-case lifetime (nom.)	70 °C
T-Case maximum (max.)	70 °C
Mechanical and Housing	
Housing	S 103x67x30

Approval and Application	
Energy efficiency index	A2
Safety standard	IEC 61347-2-3
Environmental standard	ISO 14001
Approval marks	CE marking ENEC certificate VDE-EMV certificate
Product Data	
Order product name	HF-P 160 TL5C 220-240V 50/60Hz
Full product name	HF-P 160 TL5C 220-240V 50/60HZ
Full EOC	871150092778130
Order code	92778130
Material no. (12 NC)	913700163991
SAP numerator – quantity per pack	1
EAN/UPC – Product/Case	8711500927781
Numerator – packs per outer box	36
EAN/UPC - Case	8711500927798

HF-Performer TL5 Circular

Dimensional drawing

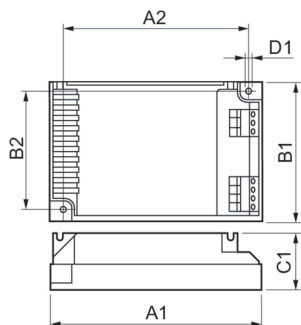

Product	D1	C1	A1	A2	B1	B2
HF-P 160 TL5C 220-240V 50/60Hz	4.5 mm	30.0 mm	103.0 mm	93.5 mm	67.0 mm	57.5 mm

