



Primaline Halogen Transformers

Primaline 70 230-240V 50/60Hz

High-Frequency electronic transformer for operation with 12V halogen lamps, available in 70W, 105W and 150W versions

Warnings and Safety

- Transformer is not suitable for DC operation
- Transformer is not suitable for DC operation

Product data

Operating and Electrical	
Input Voltage	230 to 240 V
Line Frequency	50 to 60 Hz
Input Frequency	50 to 60 Hz

Temperature	
T-Case Lifetime (Nom)	65 °C
T-Case Maximum (Max)	80 °C

Approval and Application	
Approval Marks	SELV CE marking ENEC certificate

Product Data	
Order product name	Primaline 70 230-240V 50/60Hz
Full product name	Primaline 70 230-240V 50/60Hz
Full product code	871150091266430
Order code	913700627591
Material Nr. (12NC)	913700627591
Numerator - Quantity Per Pack	1
EAN/UPC - Product/Case	8711500912664
Numerator - Packs per outer box	50
EAN/UPC - Case	8711500912671

Primaline Halogen Transformers

Dimensional drawing

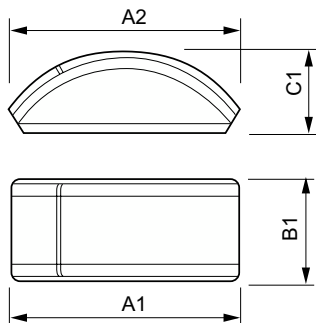

Product	C1	A1	B1
Primaline 70 230-240V 50/60Hz	33 mm	110 mm	45 mm

