



PrimaVision Xtreme for CDO

PV Xt Q 100W CDO

Highly reliable electronic drivers for CDO lamps; designed to save energy by offering better light efficiency than magnetic drivers and to reduce maintenance costs thanks to 80,000-hour lifetime and integrated lightning protection

Product data

Operating and Electrical	
Input Voltage	208-240-277 V
Line Frequency	50 to 60 Hz
Input Frequency	50 to 60 Hz
Earth Leakage Current (Max)	0.7 mA
Inrush Current Width	0.47 ms
Input Current (Nom)	0.53 A
Inrush Current Peak (Max)	52 A
Number of Products on MCB (16A Type B) (Nom)	5
Wiring	
Cable Length From Device to Lamp	10 m
Connector Type	WAGO series 804
Temperature	
Ambient temperature range	-30 °C to 55 °C
T-Case Lifetime (Nom)	80 °C

Mechanical and Housing	
Housing	Q
Approval and Application	
Surge Protection (Common/Differential)	EN61547 (L-L 2kV, L-G 4kV), 10 kV TIL
Safety Standard	IEC 607, 609, 926, 928 [No Standard for HID Lamp drivers exists. Requirements in these standards to be used if considered relevant for the product.]
Environmental Standard	ISO 14001
Approval Marks	F-Marking CE marking ENEC certificate VDE-EMV certificate

Product Data	
Order product name	PV Xt Q 100W CDO
Full product name	PV Xt Q 100W CDO
Full product code	871829169888300
Order code	69888300
Material Nr. (12NC)	913700691066
Numerator - Quantity Per Pack	1
EAN/UPC - Product/Case	8718291698883
Numerator - Packs per outer box	12

PrimaVision Xtreme for CDO

EAN/UPC - Case

8718291698890

Dimensional drawing

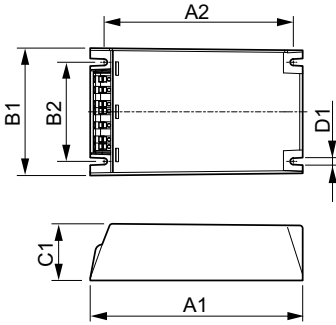

Product	D1	C1	A1	A2	B1	B2
PV Xt Q 100W CDO	4.5 mm	40.0 mm	150.0 mm	133.6 mm	90.0 mm	70.0 mm

