



MASTER LEDspot LV

MASTER LED 7-50W 927 MR16 36D Dim

Delivering intense accent beam, MASTER LEDspot LV is an ideal retrofit solution for spot lighting. MASTER LEDspot LV is designed to replace halogen or incandescent spots. It realizes natural colors, enables cozy and comfortable ambience for residential, hospitality and emphasizes the beauty of merchandise in retail. New smaller housing provides perfect fitting with majority of luminaires in a market with a MR16 GU 5.3 holder. It not only employs Philips' patented solution to guarantee the broadest possible compatibility with standard 12V halogen electronic transformers, it also delivers high beam intensity which is equivalent to halogen MR16 spots. The dimming function enables to create the desired atmosphere and it works with broad selection of dimmers. Its high SDCM ensure stricter color consistency, that is maintained over product life. MASTER LEDspot LV delivers huge energy savings and minimizes maintenance cost without any compromise on light quality and lifetime, enabling residential and business owners to achieve a return on their investment within short period time.

Product data

General Information		Operating and Electrical	
Cap-Base	GU5.3 [GU5.3]	Correlated Color Temperature (Nom)	2700 K
Nominal lifetime	40,000 hour(s)	Luminous Efficacy (rated) (Nom)	57.14 lm/W
Switching Cycle	50,000	Color Consistency	<6
Lighting Technology	LED	Color rendering index (CRI)	90
EU RoHS compliant	Yes	LLMF At End Of Nominal Lifetime (Nom)	70 %
		Luminous Flux in 90° Cone (Rated)	400 lm
Light Technical			
Color Code	927	Power Consumption	7 W
Beam Angle (Nom)	36 degree(s)	Lamp Current (Nom)	720 mA
Luminous Flux	420 lm	Wattage Equivalent	50 W
Luminous Intensity (Nom)	1,150 cd	Starting Time (Nom)	0.5 s
Color Designation	Warm White (WW)	Warm-up time to 60% light	1 s

MASTER LEDspot LV

Power Factor (Fraction)	0.7
Voltage (Nom)	12 V
Temperature	
T-Case Maximum (Nom)	92 °C
Controls and Dimming	
Dimmable	Yes
Mechanical and Housing	
Bulb Shape	MR16 [2inch/50mm]
Approval and Application	
Energy Saving Product	Yes
Suitable For Accent Lighting	Yes

Energy Consumption kWh/1000 h	8 kWh
Product Data	
Order product name	MASTER LED 7-50W 927 MR16 36D Dim
Full product name	MASTER LED 7-50W 927 MR16 36D Dim
Full product code	871869667332400
Order code	67332400
Material Nr. (12NC)	929001153138
Numerator - Quantity Per Pack	1
EAN/UPC - Product/Case	8718696673324
Numerator - Packs per outer box	10
EAN/UPC - Case	8718696673331

Dimensional drawing

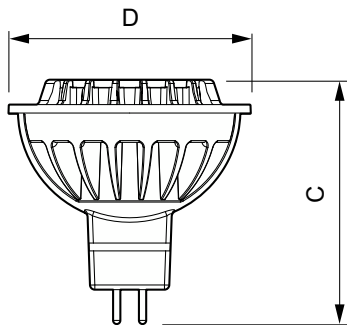

Product	D	C
MASTER LED 7-50W 927 MR16 36D Dim	51 mm	51 mm

Photometric data

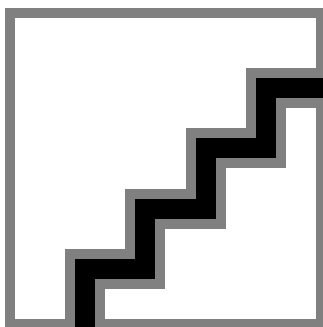

Spectral Power Distribution Colour - MASTER LED 7-50W 927 MR16 36D Dim

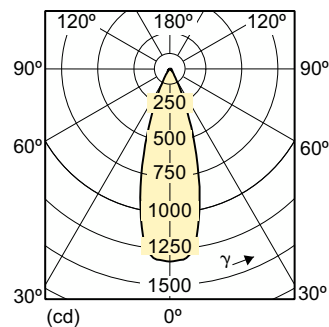

Light Distribution Diagram - MASTER LED 7-50W 927 MR16 36D Dim

MASTER LEDspot LV

Photometric data

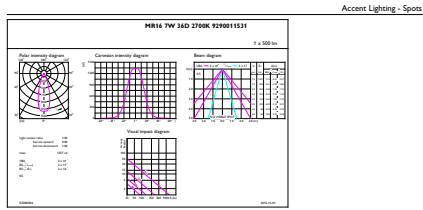

General uniform lighting - MASTER LED 7-50W 927 MR16 36D Dim

