



MASTER LEDtube EM/ Mains

MAS LEDtube 1200mm UO 18W 840 T8 RN

The Philips MASTER LEDtube integrates a LED light source into a traditional fluorescent form factor. Its unique design creates a perfectly uniform visual appearance which cannot be distinguished from traditional fluorescent. This product is the ideal solution for up lighting in general lighting applications.

Product data

General Information	
Cap base	G13 [Medium Bi-Pin Fluorescent]
Main application	Industrial
Nominal lifetime (nom.)	50000 h
Switching cycle	200000X
B50L70	50000 h
Light Technical	
Colour Code	840 [CCT of 4,000 K]
Technical Beam Angle (Nom)	160 °
Lamp Luminous Flux 25°C EL (Nom)	2500 lm
Lamp Luminous Flux (Nom)	2500 lm
Rated beam angle	160 °
Colour Temperature, horizontal (Nom)	4000 K
Lamp Luminous Efficacy EM (Nom)	139 lm/W
Colour consistency	<6
Colour Rendering Index,horiz (Nom)	83
LLMF at end of nominal lifetime (nom.)	70 %

Operating and Electrical	
Input frequency	50 to 60 Hz
Power (Rated) (Nom)	18 W
Lamp current (max.)	82 mA
Lamp current (min.)	75 mA
Starting time (nom.)	0.5 s
Warm-up time to 60% light (nom.)	0.1 s
Power factor (nom.)	0.9
Voltage (Nom)	220-240 V
Temperature	
T ambient (max.)	35 °C
T ambient (min.)	-20 °C
T storage (max.)	65 °C
T storage (min.)	-40 °C
T-Case maximum (nom.)	55 °C
Controls and Dimming	
Dimmable	No

MASTER LEDtube EM/Mains

Mechanical and Housing

Product length 1200 mm

Approval and Application

Energy efficiency label (EEL) A++
 Energy-saving product Yes
 Suitable for accent lighting No
 Approval marks CE marking KEMA Keur certificate RoHS compliance
 Energy Consumption kWh/1000 h 18 kWh

Product Data

Full product code 871869656529200
 Order product name MAS LEDtube 1200mm UO 18W 840 T8 RN
 EAN/UPC – product 8718696565292
 Order code 929001222002
 Numerator – quantity per pack 1
 Numerator – packs per outer box 10
 Material no. (12NC) 929001222002
 Net weight (piece) 0.270 kg

Warnings and Safety

· -

Dimensional drawing

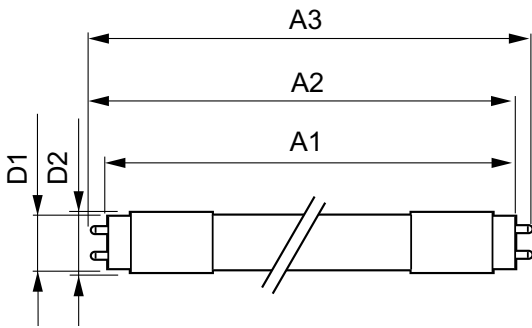

TLED 4ft 220-240V 18W-36W 4000K G13 ND

Product	D1	D2	A1	A2	A3
MAS LEDtube 1200mm UO 18W 840 T8 RN	25.78 mm	28 mm	588.6 mm	1205.3 mm	1212.4 mm

Photometric data

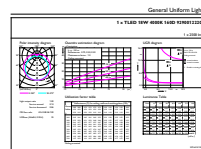
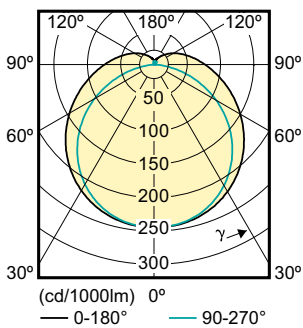

TLED 4ft 220-240V 18W-36W 4000K G13

MASTER LEDtube EM/Mains

Photometric data

