



MASTER LEDspot ExpertColor AR111



MAS ExpertColor 10.8-50W 930 AR111 24D

The MASTER LEDspot LV ExpertColor creates a warm and comfortable ambience for hospitality venues, homes and restaurants. It creates ambience with superior lighting that has a customised spectrum, high CRI and deep dimming features. The result? A beautiful lighting experience. What's more, the innovative, trimless lens design will also suit almost any interior decor with its clean and neat look. In addition, you can take advantage of the full ExpertColor family, which also includes LEDspot LV and LEDspot Par lamps.

Product data

General Information	
Cap base	G53
Nominal lifetime	40,000 h
Switching Cycle	50,000
Lighting Technology	LED
Flux measurement reference	Narrow Cone
CE mark	Yes
EU RoHS compliant	Yes
Light Technical	
Colour Code	930 [CCT of 3000K]
Beam angle (nom.)	24 degree(s)
Luminous Flux	620 lm
Luminous intensity (nom.)	3,200 cd
Colour designation	White (WH)
Correlated Colour Temperature	3000 K
Luminous efficacy (rated) (nom.)	57 lm/W
Colour consistency	<4

Colour rendering index (CRI)	95
LLMF at end of nominal lifetime (nom.)	70 %
Luminous flux in 90° cone (rated)	620 lm
Photobiological safety according to EN 62471	RG1
Operating and Electrical	
Line Frequency	50 to 60 Hz
Input frequency	50 to 60 Hz
Power Consumption	10.8 W
Lamp current (nom.)	1,000 mA
Wattage equivalent	50 W
Starting time (nom.)	0.5 s
Warm-up time to 60% light	0.5 s
Power Factor (Fraction)	0.7
Voltage (nom.)	ac electronic 12 V

MASTER LEDspot ExpertColor AR111

Temperature

T-Case maximum (nom.)	70 °C
-----------------------	-------

Controls and Dimming

Dimmable	Only with specific dimmers
----------	----------------------------

Mechanical and Housing

Lamp Finish	Clear
Bulb shape	AR111

Approval and Application

Energy Efficiency Class	G
Suitable for accent lighting	Yes
Energy consumption kWh/1,000 hours	11 kWh
EPREL registration number	648247
EyeComfort	Yes

Application Conditions

Can it be used in closed luminaires	No
-------------------------------------	----

Product Data

Order product name	MAS ExpertColor 10.8-50W 930 AR111 24D
Full product name	MAS ExpertColor 10.8-50W 930 AR111 24D
Full EOC	871951433399400
Order code	33399400
Material no. (12 NC)	929003043602
SAP numerator – quantity per pack	1
EAN/UPC – Product/Case	8719514333994
Numerator – packs per outer box	6
EAN/UPC - Case	8719514334007

Dimensional drawing

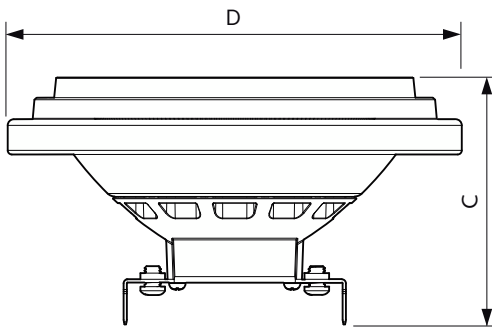

Product	D	C
MAS ExpertColor 10.8-50W 930 AR111 24D	111 mm	61 mm

Photometric data

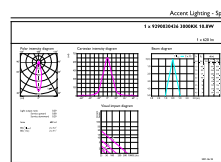
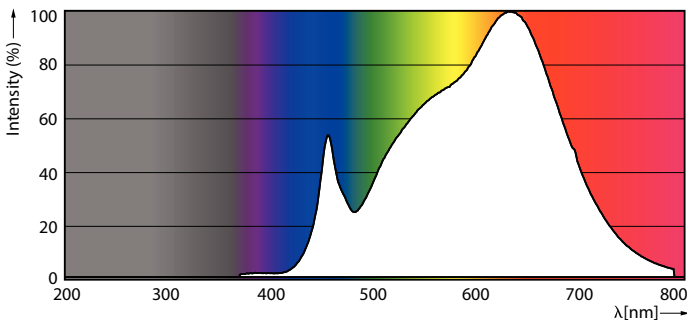

Spectral Power Distribution Colour - MAS ExpertColor 10.8-50W 930 AR111 24D

Accent Lighting Spots - MAS ExpertColor 10.8-50W 930 AR111 24D

MASTER LEDspot ExpertColor AR111

Photometric data

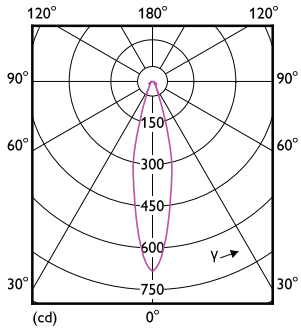

Light Distribution Diagram - MAS ExpertColor 10.8-50W 930 AR111 24D

Lifetime



Life Expectancy Diagram - MAS ExpertColor 10.8-50W 930 AR111 24D



Lumen Maintenance Diagram - MAS ExpertColor 10.8-50W 930 AR111 24D

