

PHILIPS

HARMONY 1 LED

BGP660

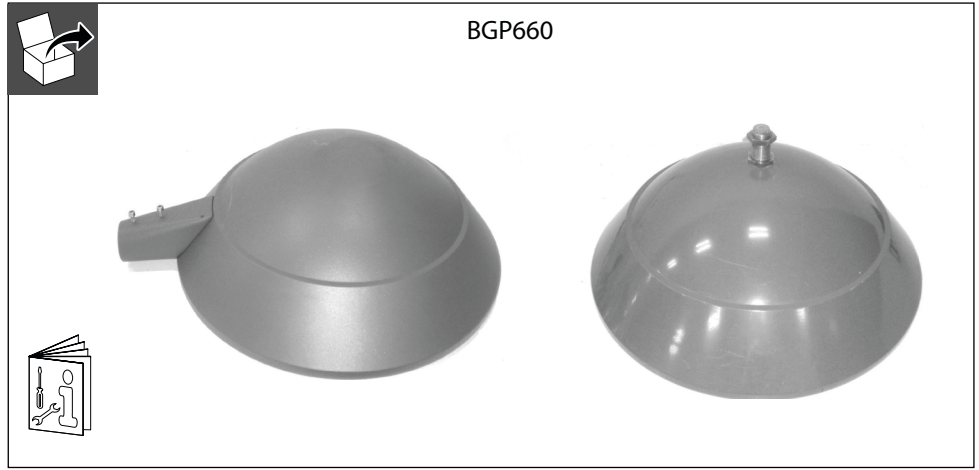



BOWL GLASS

This luminaire must be installed only by qualified personnel

Disconnect before servicing

led color	ledgine	LEDs	W +/- 10%	lumen
740	LED17-4S	12	11	1700
740	LED22-4S	12	14	2200
740	LED29-4S	20	18	2900
740	LED33-4S	20	21	3300
740	LED40-4S	30	25	4000
740	LED43-4S	30	26	4300
740	LED52-4S	40	31	5200
740	LED57-4S	40	34	5800
740	LED65-4S	40	39	6500
740	LED71-4S	40	42	7100
740	LED84-4S	40	50	8400
740	LED92-4S	40	55	9200
740	LED100-4S	40	60	10000
740	LED110-4S	40	67	11000
740	LED120-4S	40	74	12000

 led color	 ledgine	LEDs	W +/-10%	lumen
830	LED14-4S	12	12	1400
830	LED20-4S	20	16	2000
830	LED25-4S	20	20	2500
830	LED29-4S	30	22	2900
830	LED35-4S	30	27	3500
830	LED38-4S	30	29	3800
830	LED47-4S	40	35	4700
830	LED50-4S	40	37	5000
830	LED57-4S	40	42	5700
830	LED61-4S	40	45	6100
830	LED73-4S	40	54	7300
830	LED80-4S	40	60	8000
830	LED90-4S	40	68	9000
830	LED100-4S	40	77	10000

i Mounting Device

Side Entry -60S-

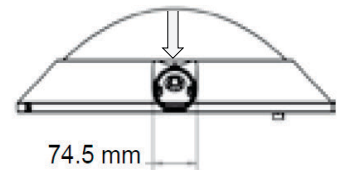
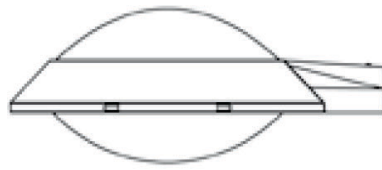
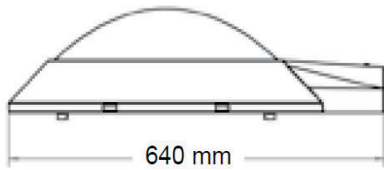

Dedicated Bracket -MB-

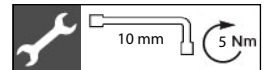
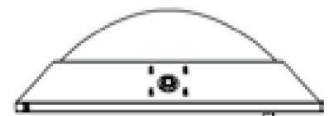
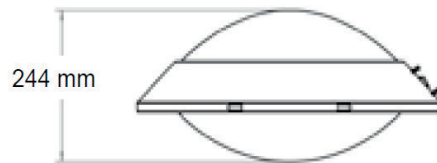
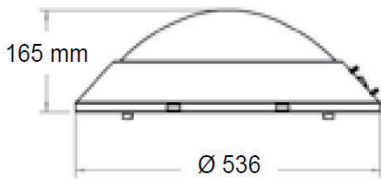

Suspended Fixation -G1-

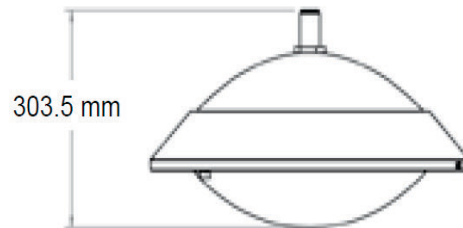
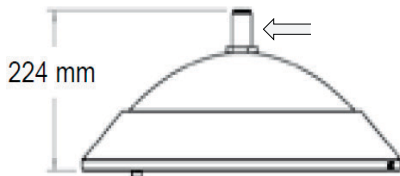

Post-Top Fixation -60P-

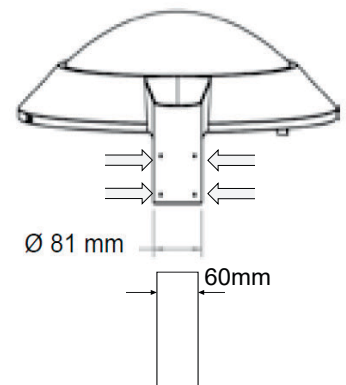
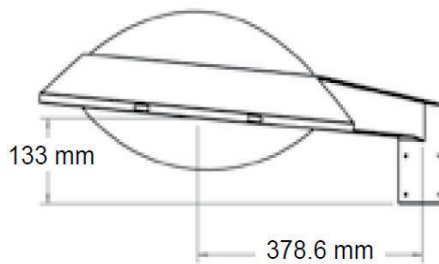
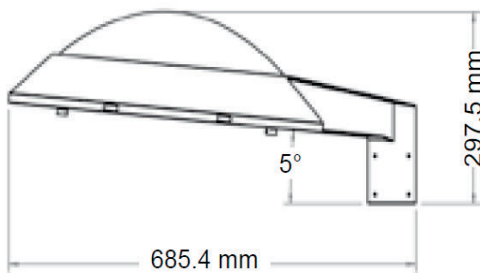



Luminaire opening

1

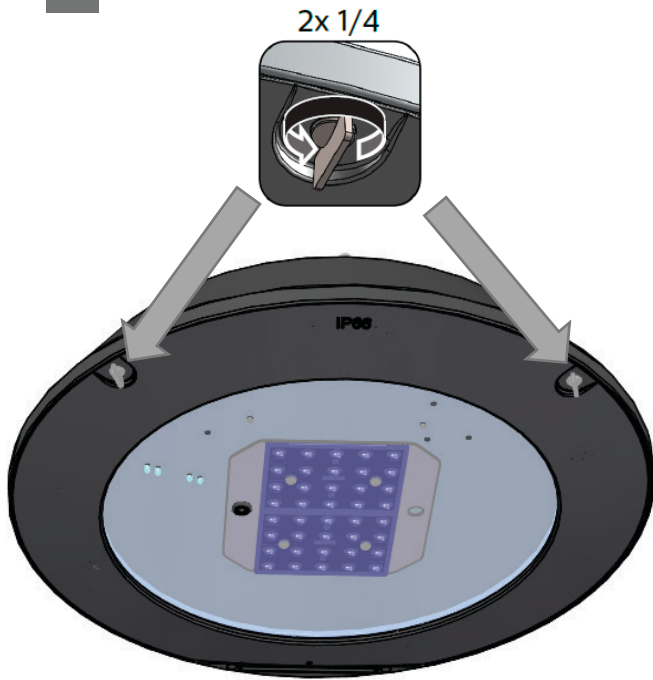

2

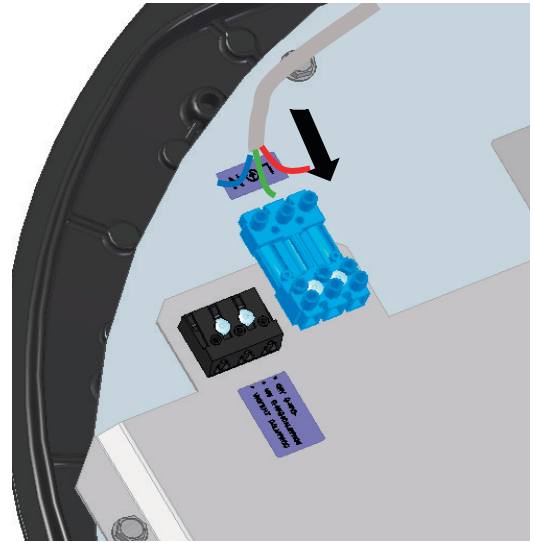

3

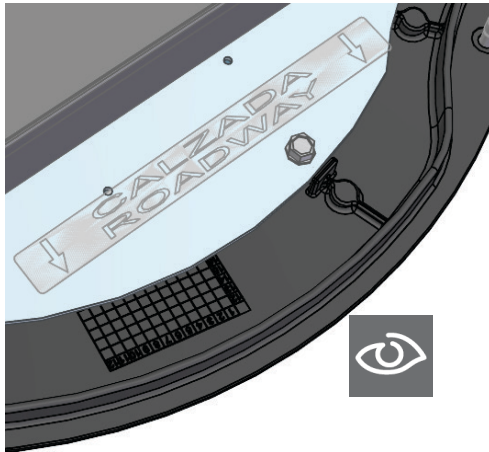



ELECTRICAL CONNECTIONS

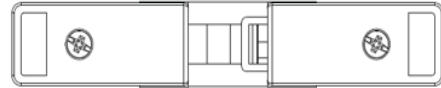
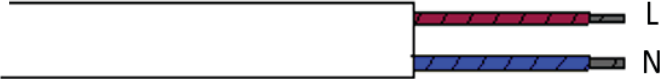
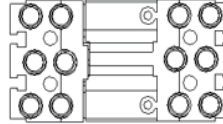
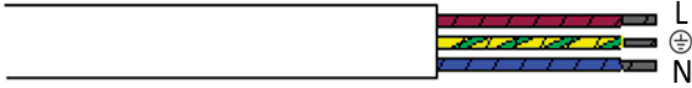

DALI

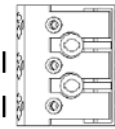
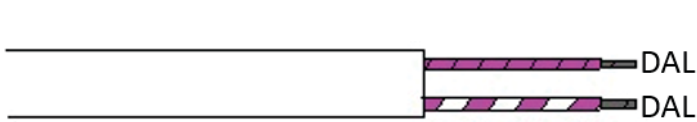
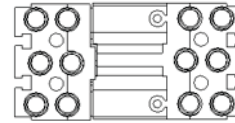
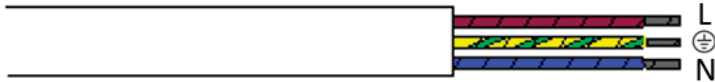

DALI

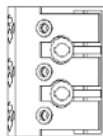
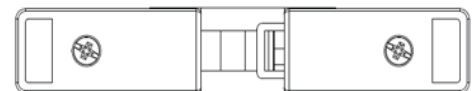
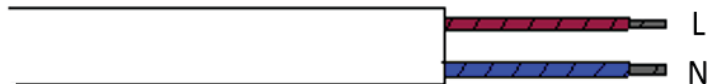

LINE SWITCH

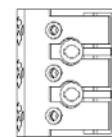
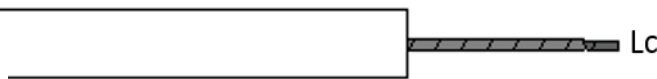
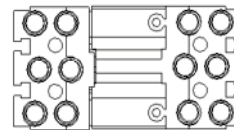

LINE SWITCH

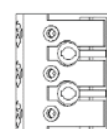
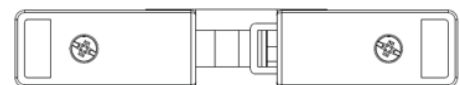
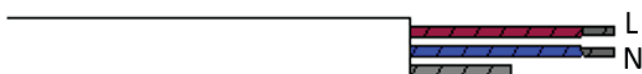



Closure

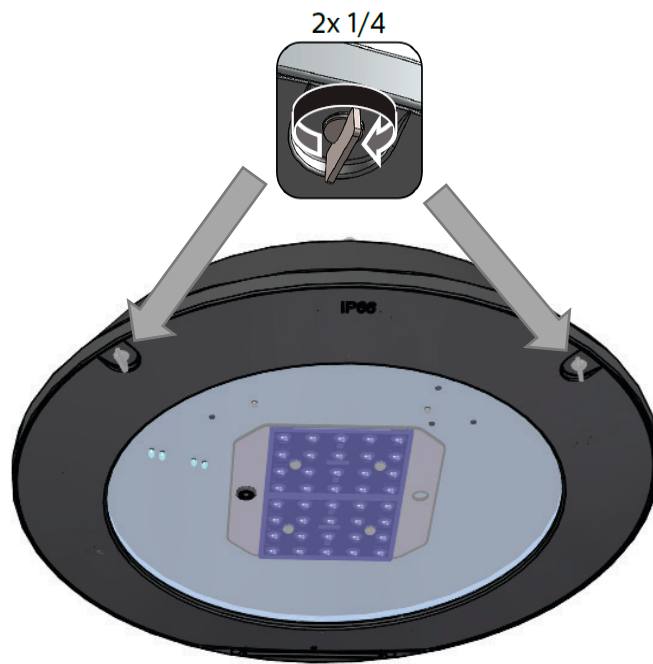



© 2018 Signify Holding.

All rights reserved. This document contains information relating to the product portfolio of Signify which information may be subject to change. No representation or warranty as to the accuracy or completeness of the information included herein is given and any liability for any action in reliance thereon is disclaimed. The information presented in this document is not intended as any commercial offer and does not form part of any quotation or contract. Philips and the Philips Shield Emblem are registered trademarks of Koninklijke Philips N.V.. All other trademarks are owned by Signify Holding or their respective owners.

Signify Holding.
The Netherlands