



Perfect sparkle, easy application

MASTERColour CDM-Rm Elite Mini

Mini, very high-efficiency Ceramic Metal Halide discharge reflector lamp producing crisp white sparkling light with high colour rendering

Benefits

- High-intensity beam of crisp white sparkling light makes merchandise look irresistible
- Easy to install and replace, reducing installation and relamping costs
- Fits in small luminaires which are less visible

Features

- Crisp white sparkling light
- Excellent colour rendering, with extra red
- High efficacy with unparalleled lumen maintenance
- Mini design fitting in open luminaires
- UV-blocking front glass

Application

- Accent and display lighting in retail
- General and decorative indoor lighting

MASTERColour CDM-Rm Elite Mini

Versions



Dimensional drawing

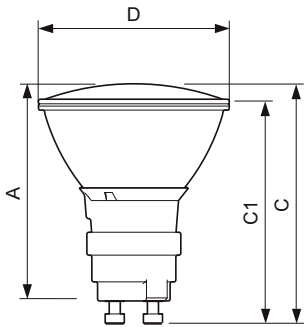

Product	D (max)	D	C (max)	C	C1 (max)	A (max)
MASTERColour CDM-Rm Elite Mini 35W/930 GX10 MR16 40D	51 mm	50 mm	65.4 mm	62.75 mm	60.9 mm	59 mm
MASTERColour CDM-Rm Elite Mini 20W/830 GX10 MR16 40D	51 mm	50 mm	65.4 mm	62.75 mm	60.9 mm	59 mm
CDM-Rm Elite Mini 20W/830 GX10 MR16 25D	51 mm	50 mm	65.4 mm	62.75 mm	60.9 mm	59 mm

MASTERColour CDM-Rm Elite Mini

Approval and Application

Energy Efficiency Label (EEL) A

Controls and Dimming

Dimmable no

Operating and Electrical

Re-Ignition Time (Min) (Max) 15 min

Warm Up Time To 60% Light (Nom) 120 s

General Information

Cap-Base GX10

Life To 10% Failures (Nom) 10000 h

Life To 20% Failures (Nom) 12000 h

Life To 50% Failures (Nom) 15000 h

Life To 5% Failures (Nom) 9000 h

Operating Position UNIVERSAL

Switching Cycle 1350X

Light Technical

Beam Description -

Chromaticity Coordinate X (Nom) 0.439

Chromaticity Coordinate Y (Nom) 0.403

Correlated Colour Temperature (Nom) 3000 K

Mechanical and Housing

Bulb Finish -

Bulb Shape MR16

Approval and Application

Order Code	Full Product Name	Energy Consumption kWh/1000 h	Mercury (Hg) Content (Nom)
928191105331	CDM-Rm Elite Mini 20W/830 GX10 MR16 25D	22 kWh	3.5 mg
928191205331	MASTERColour CDM-Rm Elite Mini 20W/830 GX10 MR16 40D	22 kWh	3.5 mg
928194805330	MASTERColour CDM-Rm Elite Mini 35W/930 GX10 MR16 40D	43 kWh	4.7 mg

Operating and Electrical

Order Code	Full Product Name	Voltage (Max)	Voltage (Min)	Voltage (Nom)	Power (Rated) (Nom)
928191105331	CDM-Rm Elite Mini 20W/830 GX10 MR16 25D	100 V	90 V	95 V	20 W
928191205331	MASTERColour CDM-Rm Elite Mini 20W/830 GX10 MR16 40D	100 V	90 V	95 V	20.0 W

Order Code	Full Product Name	Voltage (Max)	Voltage (Min)	Voltage (Nom)	Power (Rated) (Nom)
928194805330	MASTERColour CDM-Rm Elite Mini 35W/930 GX10 MR16 40D	95 V	79 V	87 V	39 W

Light Technical (1/2)

Order Code	Full Product Name	Beam Angle (Nom)	Colour Code	Colour Rendering Index (Min)	Colour Rendering Index (Nom)
928191105331	CDM-Rm Elite Mini 20W/830 GX10 MR16 25D	25 °	830	81	84
928191205331	MASTERColour CDM-Rm Elite Mini 20W/830 GX10 MR16 40D	40 °	830	81	84

Order Code	Full Product Name	Beam Angle (Nom)	Colour Code	Colour Rendering Index (Min)	Colour Rendering Index (Nom)
928194805330	MASTERColour CDM-Rm Elite Mini 35W/930 GX10 MR16 40D	40 °	930	88	91

MASTERColour CDM-Rm Elite Mini

Light Technical (2/2)

Order Code	Full Product Name	Llmf At End								
		Of Nominal Lifetime (Nom)	Lumen Maintenance 12000 h (Nom)	Lumen Maintenance 2000 h (Nom)	Lumen Maintenance 4000 h (Nom)	Luminous Efficacy (rated) (Nom)	Luminous Flux (Rated) (Min)	Luminous Flux (Rated) (Nom)	Luminous Intensity (Min)	Luminous Intensity (Nom)
928191105331	CDM-Rm Elite Mini 20W/830 GX10 MR16 25D	70 %	75 %	90 %	85 %	50 lm/W	900 lm	1000 lm	3100 cd	4100 cd
928191205331	MASTERColour CDM-Rm Elite Mini 20W/830 GX10 MR16 40D	70 %	75 %	90 %	85 %	50 lm/W	900 lm	1000 lm	1350 cd	1750 cd
928194805330	MASTERColour CDM-Rm Elite Mini 35W/930 GX10 MR16 40D	80 %	85 %	95 %	93 %	61 lm/W	-	-	2700 cd	3600 cd

Colour Rendering Diagrams

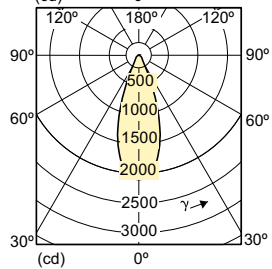
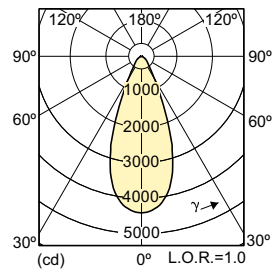
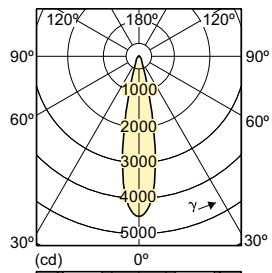
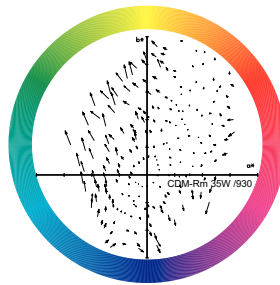
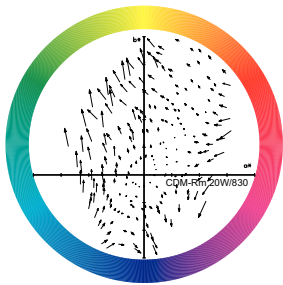

MASTERColour CDM-Rm Elite Mini

Accent Diagrams

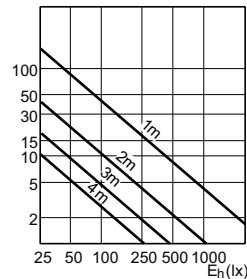
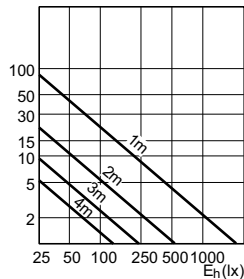
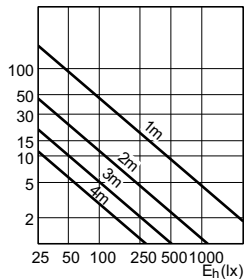

Beam Diagrams

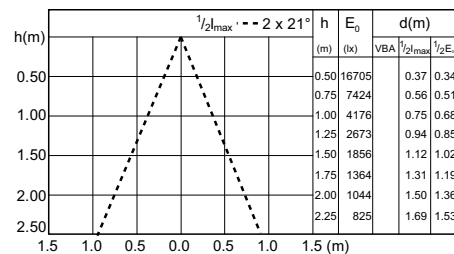
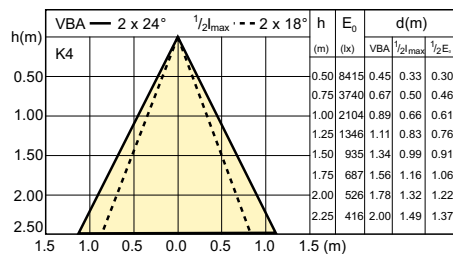
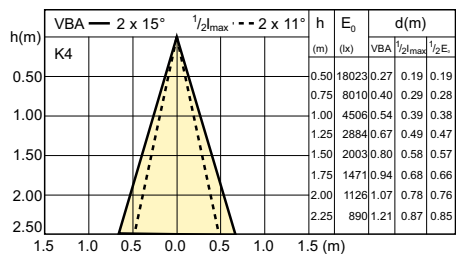

LDBE_CDM-Rm_20W_25D_0003-Beam diagram

LDBE_CDM-Rm_20W_40D_0003-Beam diagram

LDBE_CDM-Rm_35W_930_40D-Beam diagram

