



# Perfect sparkle, easy application

## MASTERColour CDM-Rm Elite Mini

Mini, very high-efficiency Ceramic Metal Halide discharge reflector lamp producing crisp white sparkling light with high colour rendering

### Benefits

- High-intensity beam of crisp white sparkling light makes merchandise look irresistible
- Easy to install and replace, reducing installation and relamping costs
- Fits in small luminaires which are less visible

### Features

- Crisp white sparkling light
- Excellent colour rendering, with extra red
- High efficacy with unparalleled lumen maintenance
- Mini design fitting in open luminaires
- UV-blocking front glass

### Application

- Accent and display lighting in retail
- General and decorative indoor lighting

### Warnings and Safety

- Use only with electronic control gear
- Control gear must include end-of-life protection (IEC61167, IEC 62035)

# MASTERColour CDM-Rm Elite Mini

## Versions



LPPR CDM-Rm 0008

## Dimensional drawing

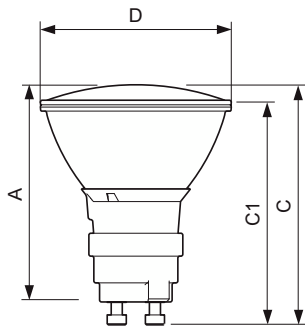

Product	D (max)	D	C (max)	C	C1 (max)	A (max)
CDM-Rm Elite Mini 20W/830 GX10 MR16 10D	51 mm	50 mm	65.4 mm	62.75 mm	60.9 mm	59 mm
CDM-Rm Elite Mini 20W/830 GX10 MR16 25D	51 mm	50 mm	65.4 mm	62.75 mm	60.9 mm	59 mm
CDM-Rm Elite Mini 20W/830 GX10 MR16 40D	51 mm	50 mm	65.4 mm	62.75 mm	60.9 mm	59 mm
CDM-Rm Elite Mini 35W/930 GX10 MR16 10D	51 mm	50 mm	65.4 mm	62.75 mm	60.9 mm	59 mm
CDM-Rm Elite Mini 35W/930 GX10 MR16 25D	51 mm	50 mm	65.4 mm	62.75 mm	60.9 mm	59 mm
CDM-Rm Elite Mini 35W/930 GX10 MR16 40D	51 mm	50 mm	65.4 mm	62.75 mm	60.9 mm	59 mm

### General Information

Cap-Base	GX10
Switching Cycle	1,350
Operating Position	UNIVERSAL

### Light Technical

Chromaticity Coordinate X (Nom)	0.434
Chromaticity Coordinate Y (Nom)	0.398
Correlated Color Temperature (Nom)	3000 K

### Operating and Electrical

Warm-up time to 60% light	120 s
---------------------------	-------

### Controls and Dimming

Dimmable	No
----------	----

### Mechanical and Housing

Bulb Shape	MR16
------------	------

## Light Technical (1/2)

Order Code	Full Product Name	Beam Angle (Nom)	Color rendering index (CRI)	LLMF At End Of Nominal Lifetime (Nom)	Luminous Efficacy (rated) (Nom)
928191005331	CDM-Rm Elite Mini 20W/830 GX10 MR16 10D	10 degree(s)	84	70 %	49 lm/W
928191105331	CDM-Rm Elite Mini 20W/830 GX10 MR16 25D	25 degree(s)	84	70 %	50 lm/W
928191205331	CDM-Rm Elite Mini 20W/830 GX10 MR16 40D	40 degree(s)	84	70 %	50 lm/W
928194605330	CDM-Rm Elite Mini 35W/930 GX10 MR16 10D	10 degree(s)	90	80 %	60 lm/W
928194705330	CDM-Rm Elite Mini 35W/930 GX10 MR16 25D	25 degree(s)	90	80 %	60 lm/W
928194805330	CDM-Rm Elite Mini 35W/930 GX10 MR16 40D	40 degree(s)	90	80 %	61 lm/W

## Light Technical (2/2)

# MASTERCLOUR CDM-Rm Elite Mini

Order Code	Full Product Name	Luminous	
		Luminous Flux	Intensity (Nom)
928191005331	CDM-Rm Elite Mini 20W/830 GX10 MR16 10D	880 lm	14,500 cd
928191105331	CDM-Rm Elite Mini 20W/830 GX10 MR16 25D	900 lm	4,000 cd
928191205331	CDM-Rm Elite Mini 20W/830 GX10 MR16 40D	860 lm	1,750 cd

Order Code	Full Product Name	Luminous	
		Luminous Flux	Intensity (Nom)
928194605330	CDM-Rm Elite Mini 35W/930 GX10 MR16 10D	2,100 lm	17,500 cd
928194705330	CDM-Rm Elite Mini 35W/930 GX10 MR16 25D	2,150 lm	7,600 cd
928194805330	CDM-Rm Elite Mini 35W/930 GX10 MR16 40D	2,150 lm	3,600 cd

## Operating and Electrical

Order Code	Full Product Name	Voltage (Nom)	Power
			Consumption
928191005331	CDM-Rm Elite Mini 20W/830 GX10 MR16 10D	95 V	20.1 W
928191105331	CDM-Rm Elite Mini 20W/830 GX10 MR16 25D	95 V	20.1 W
928191205331	CDM-Rm Elite Mini 20W/830 GX10 MR16 40D	95 V	20.1 W

Order Code	Full Product Name	Voltage (Nom)	Power
			Consumption
928194605330	CDM-Rm Elite Mini 35W/930 GX10 MR16 10D	87 V	39.1 W
928194705330	CDM-Rm Elite Mini 35W/930 GX10 MR16 25D	87 V	39.1 W
928194805330	CDM-Rm Elite Mini 35W/930 GX10 MR16 40D	87 V	39.1 W

## Approval and Application

Order Code	Full Product Name	Energy Consumption kWh/1000 h	Mercury	Mercury
			Content (Hg) (Max)	Content (Hg) (Nom)
928191005331	CDM-Rm Elite Mini 20W/830 GX10 MR16 10D	21 kWh	3.5 mg	3.5 mg
928191105331	CDM-Rm Elite Mini 20W/830 GX10 MR16 25D	21 kWh	3.5 mg	3.5 mg
928191205331	CDM-Rm Elite Mini 20W/830 GX10 MR16 40D	21 kWh	3.5 mg	3.5 mg
928194605330	CDM-Rm Elite Mini 35W/930 GX10 MR16 10D	40 kWh	4.7 mg	4.7 mg
928194705330	CDM-Rm Elite Mini 35W/930 GX10 MR16 25D	40 kWh	4.7 mg	4.7 mg
928194805330	CDM-Rm Elite Mini 35W/930 GX10 MR16 40D	40 kWh	4.7 mg	4.7 mg

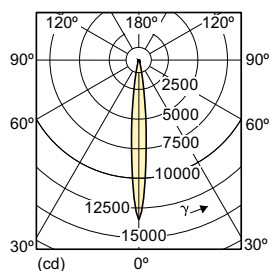
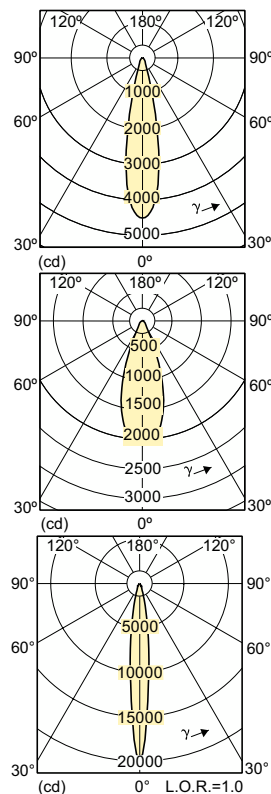

# MASTERColour CDM-Rm Elite Mini

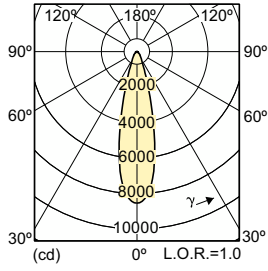

## Accent Diagrams

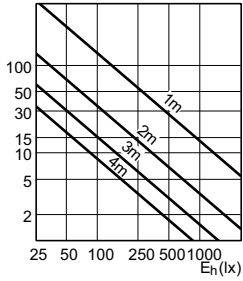

Accent Diagram - CDM-Rm Elite Mini 20W/830 GX10 MR16 10D

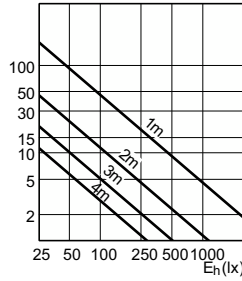

Accent Diagram - CDM-Rm Elite Mini 20W/830 GX10 MR16 25D

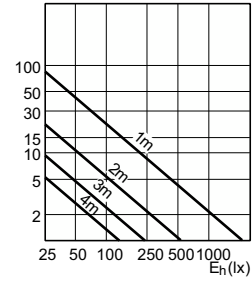

Accent Diagram - CDM-Rm Elite Mini 20W/830 GX10 MR16 40D

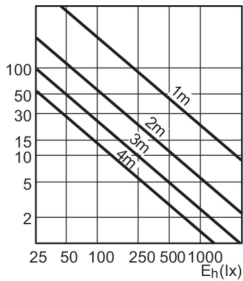

Accent Diagram - CDM-Rm Elite Mini 35W/930 GX10 MR16 10D

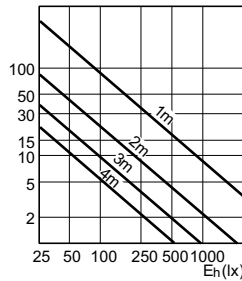

Accent Diagram - CDM-Rm Elite Mini 35W/930 GX10 MR16 25D

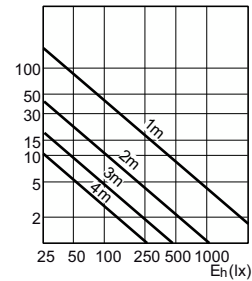

Accent Diagram - CDM-Rm Elite Mini 35W/930 GX10 MR16 40D

## Beam Diagrams

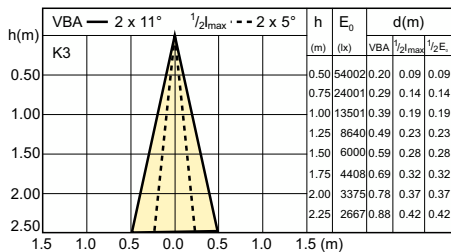

Beam diagram - CDM-Rm Elite Mini 20W/830 GX10 MR16 10D

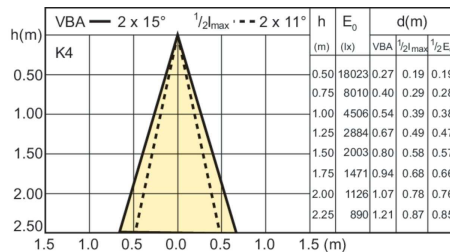

Beam diagram - CDM-Rm Elite Mini 20W/830 GX10 MR16 25D

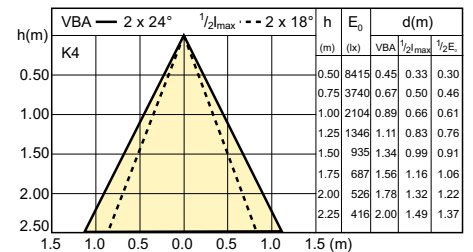

Beam diagram - CDM-Rm Elite Mini 20W/830 GX10 MR16 40D

# MASTERCoulour CDM-Rm Elite Mini

## Beam Diagrams

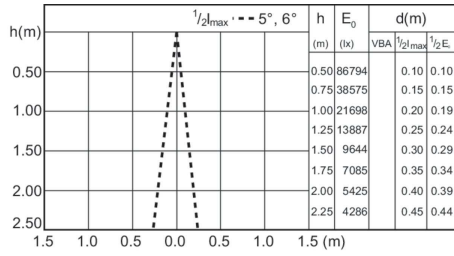

Beam diagram - CDM-Rm Elite Mini 35W/930  
GX10 MR16 10D

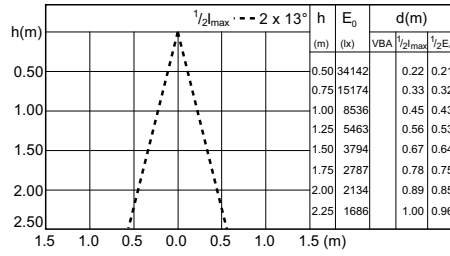

Beam diagram - CDM-Rm Elite Mini 35W/930  
GX10 MR16 25D

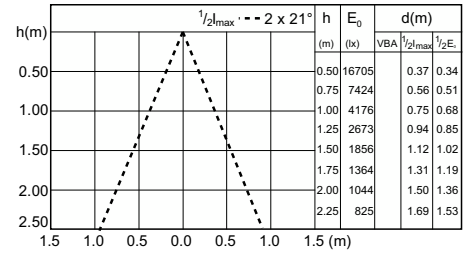

Beam diagram - CDM-Rm Elite Mini 35W/930  
GX10 MR16 40D

