



Product Description

HF-Regulator II for TL-D lamps

Flat, lightweight high-frequency electronic regulating ballast, using 1-10V protocol for TL-D fluorescent lamps

Benefits

- The lamp power can be dimmed from 1 to 100% via the Analog control input (in accordance with the 1-10 V industry standard)
- Compliant with European and Asian norms and suitable for emergency lighting systems
- HF operation improves light quality, lamp lifetime
- Combined with controls, additional energy savings can be achieved

Features

- Programmed start: flicker-free ignition < 0.5 seconds and striation-free operation, no stroboscopic effects. Preheating the lamp electrodes enables the lamps to be switched on and off without reducing life
- Smart power ensures constant light, independent of mains fluctuations.
- Up to 60% reduction in energy consumption by using automatic lighting control systems
- Stop circuit is activated within 5 seconds in the event of lamp failure (safety stop), and ballast resets automatically after lamp replacement

Application

- 1-10V installations with daylight linking and/or movement detection (for energy savings)
- 1-10V installations with remote control systems (combining energy savings with comfort)
- Installations with emergency back-up, according to IEC 60598-2-22

HF-Regulator II for TL-D lamps

Dimensional drawing

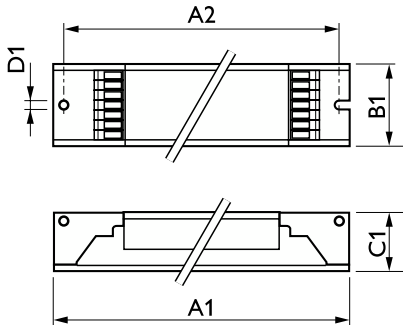

Product	D1	C1	A1	A2	B1
HF-R 136 TL-D EII 220-240V 50/60Hz	4.2 mm	22 mm	360 mm	350 mm	30 mm
HF-R 158 TL-D EII 220-240V 50/60Hz	4.2 mm	22 mm	360 mm	350 mm	30 mm
HF-R 236 TL-D EII 220-240V 50/60Hz	4.2 mm	22 mm	360 mm	350 mm	30 mm
HF-R 258 TL-D EII 220-240V 50/60Hz	4.2 mm	22 mm	360 mm	350 mm	30 mm

Operating and Electrical

Input frequency	50 to 60 Hz
Input Voltage	220 to 240 V
Line Frequency	50 to 60 Hz

Mechanical and Housing

Housing	L 360x30x21
---------	-------------

Approval and Application

Energy efficiency index	A1 BAT
-------------------------	--------

Operating and Electrical

Order Code	Full Product Name	Number of products on MCB (16 A type B) (nom.)
91013430	HF-R 136 TL-D EII 220-240V 50/60Hz	28
91015830	HF-R 236 TL-D EII 220-240V 50/60Hz	12

Order Code	Full Product Name	Number of products on MCB (16 A type B) (nom.)
91017230	HF-R 158 TL-D EII 220-240V 50/60Hz	28
91019630	HF-R 258 TL-D EII 220-240V 50/60Hz	12

