



DimTone, beste Farbwiedergabe und lange Nutzlebensdauer - die hochwertige Type

MASTER LEDbulb Glühlampenform

Die MASTER LEDbulb ist mit ihrer langen Nutzlebensdauer ideal für den Dauerbetrieb beispielsweise in der Hotellerie geeignet. Das Produkt verfügt über eine exzellente Farbwiedergabe und ist mit der DimTone Technologie ausgestattet - das Licht wird dank DimTone beim Dimmen wärmer - wie bei einer Glühlampe.

Vorteile

- DimTone: Das Licht wird beim Dimmen wärmer von 2.700 auf 2.200 Kelvin
- Min. 80% Energieeinsparung im Vergleich zu Standardglühlampen bei vergleichbarer Lichtleistung und Zeitspanne
- Schnelle Amortisation

Merkmale

- Sehr gute Farbwiedergabe
- Echtes Glühlampen-Warmweiß
- Ausstrahlungswinkel von 300°
- Stufenlos dimmbar
- Keine UV- und IR-Strahlung und nur sehr geringe Wärmeentwicklung

MASTER LEDbulb Glühlampenform

Anwendung

- Für Allgemeinbeleuchtung in Hotels, Restaurants, Krankenhäusern oder Shops
- Nur in offenen/belüfteten Leuchten verwenden
- Einzusetzen im Innenbereich bei Temperaturen von -20 bis +45°C

Versions



Abmessungsskizzen

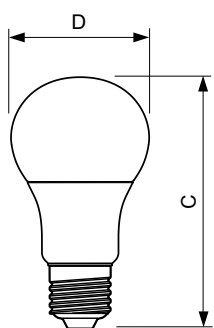

Product	D	C
MAS LEDbulb DT 8.5-60W E27 A60 CL	60 mm	110 mm
MAS LED bulb DT 5.5-40WE27 927-922 A60FR	60 mm	110 mm

MASTER LEDbulb Glühlampenform

Abmessungsskizzen

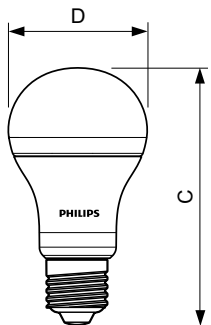

Product	D	C
MAS LED bulb DT 9-60W E27 927-922 A60 FR	60 mm	110 mm

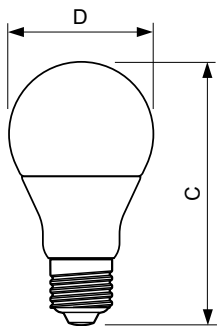

Product	D	C
MAS LED bulb DT 12-75WE27 927-922 A67 FR	77 mm	142 mm

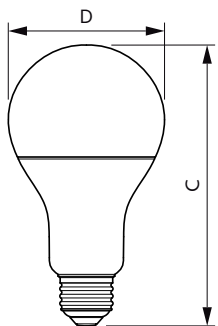

Product	D	C
MASLEDbulb DT 14-100WE27 927-922 A67FR	77 mm	142 mm

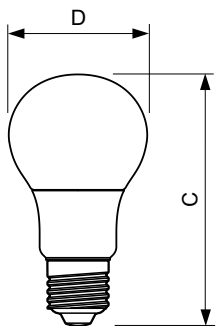

Product	D	C
MAS LEDbulb DT 6-40W E27 A60 CL	60 mm	110 mm

MASTER LEDbulb Glühlampenform

Zulassungen und Anwendungseigenschaften

Energieeffizienz-Label (EEL) A+

Dimmen

Dimmbar Ja

Elektrische Kenndaten

Eingangsfrequenz 50 bis 60 Hz

Spannung (nom.) 220-240 V

Allgemeine Eigenschaften

Sockel E27

Nennlebensdauer (nom.) 25000 h

Nennlebensdauer (Std.) 25000 h

Lichttechnische Daten

Ähnlichste Farbtemperatur (nom.) 2200-2700 K

Restlichtstrom am Ende der Nennlebensdauer (nom.) 70 %

Zulassungen und Anwendungseigenschaften

Order Code	Full Product Name	Energieverbrauch kWh/1.000 Std.
48128800	MAS LEDbulb DT 6-40W E27 A60 CL	6 kWh
48132500	MAS LEDbulb DT 8.5-60W E27 A60 CL	9 kWh
70709800	MAS LED bulb DT 5.5-40WE27 927-922 A60FR	6 kWh
70711100	MAS LED bulb DT 9-60W E27 927-922 A60 FR	9 kWh
82618800	MAS LED bulb DT 12-75WE27 927-922 A67 FR	12 kWh
69564400	MASLEDbulb DT 14-100WE27 927-922 A67FR	14 kWh

Elektrische Kenndaten

Order Code	Full Product Name	Nennleistung (nom.)	Startzeit (nom.)
48128800	MAS LEDbulb DT 6-40W E27 A60 CL	6 W	0,5 s
48132500	MAS LEDbulb DT 8.5-60W E27 A60 CL	8,5 W	0,5 s
70709800	MAS LED bulb DT 5.5-40WE27 927-922 A60FR	5,5 W	0,3 s

Order Code	Full Product Name	Nennleistung (nom.)	Startzeit (nom.)
70711100	MAS LED bulb DT 9-60W E27 927-922 A60 FR	9 W	0,3 s
82618800	MAS LED bulb DT 12-75WE27 927-922 A67 FR	12 W	0,1 s
69564400	MASLEDbulb DT 14-100WE27 927-922 A67FR	14 W	0,5 s

Allgemeine Eigenschaften

Order Code	Full Product Name	Schaltzyklus
48128800	MAS LEDbulb DT 6-40W E27 A60 CL	50000X
48132500	MAS LEDbulb DT 8.5-60W E27 A60 CL	50000X
70709800	MAS LED bulb DT 5.5-40WE27 927-922 A60FR	100000X

Order Code	Full Product Name	Schaltzyklus
70711100	MAS LED bulb DT 9-60W E27 927-922 A60 FR	100000X
82618800	MAS LED bulb DT 12-75WE27 927-922 A67 FR	100000X
69564400	MASLEDbulb DT 14-100WE27 927-922 A67FR	100000X

Lichttechnische Daten (1/2)

Order Code	Full Product Name	Ausstrahlungswinkel (nom.)	Farbwiedergabeindex (nom.)	Lichtstrom (nom.)	Order Code	Full Product Name	Ausstrahlungswinkel (nom.)	Farbwiedergabeindex (nom.)	Lichtstrom (nom.)
48128800	MAS LEDbulb DT 6-40W E27 A60 CL	-	822 - 80	470 lm	70711100	MAS LED bulb DT 9-60W E27 927-922 A60 FR	200 °	922-927 90	806 lm
48132500	MAS LEDbulb DT 8.5-60W E27 A60 CL	-	822 - 80	806 lm	82618800	MAS LED bulb DT 12-75WE27 927-922 A67 FR	200 °	922-927 90	1055 lm
70709800	MAS LED bulb DT 5.5-40WE27 927-922 A60FR	200 °	922-927 90	470 lm					

MASTER LEDbulb Glühlampenform

Order Code	Full Product Name	Ausstrahlungswinkel (nom.)	Farbwiedergabeindex (nom.)	Lichtstrom (nom.)	Order Code	Full Product Name	Ausstrahlungswinkel (nom.)	Farbwiedergabeindex (nom.)	Lichtstrom (nom.)
	12-75WE27					14-100WE27			
	927-922 A67					927-922			
	FR					A67FR			
69564400	MASLEDbulb DT	200 °	922-927 90	1521 lm					
	DT								

Lichttechnische Daten (2/2)

Order Code	Full Product Name	Nennlichtstrom (nom.)
48128800	MAS LEDbulb DT 6-40W E27 A60 CL	470 lm
48132500	MAS LEDbulb DT 8.5-60W E27 A60 CL	806 lm
70709800	MAS LED bulb DT 5.5-40WE27 927-922 A60FR	470 lm

Order Code	Full Product Name	Nennlichtstrom (nom.)
70711100	MAS LED bulb DT 9-60W E27 927-922 A60 FR	806 lm
82618800	MAS LED bulb DT 12-75WE27 927-922 A67 FR	1055 lm
69564400	MASLEDbulb DT 14-100WE27 927-922 A67FR	1521 lm

Mechanische Kenndaten

Order Code	Full Product Name	Kolbenausführung	Kolbenform
48128800	MAS LEDbulb DT 6-40W E27 A60 CL	Klar (CL)	A60
48132500	MAS LEDbulb DT 8.5-60W E27 A60 CL	Klar (CL)	A60
70709800	MAS LED bulb DT 5.5-40WE27 927-922 A60FR	matt (FR)	A60
70711100	MAS LED bulb DT 9-60W E27 927-922 A60 FR	matt (FR)	A60

Order Code	Full Product Name	Kolbenausführung	Kolbenform
82618800	MAS LED bulb DT 12-75WE27 927-922 A67 FR	matt (FR)	A67
69564400	MASLEDbulb DT 14-100WE27 927-922 A67FR	matt (FR)	A67

Temperaturkenndaten

Order Code	Full Product Name	Gehäusetemperatur (max.)
48128800	MAS LEDbulb DT 6-40W E27 A60 CL	85 °C
48132500	MAS LEDbulb DT 8.5-60W E27 A60 CL	110 °C
70709800	MAS LED bulb DT 5.5-40WE27 927-922 A60FR	70 °C
70711100	MAS LED bulb DT 9-60W E27 927-922 A60 FR	85 °C
82618800	MAS LED bulb DT 12-75WE27 927-922 A67 FR	80 °C
69564400	MASLEDbulb DT 14-100WE27 927-922 A67FR	90 °C

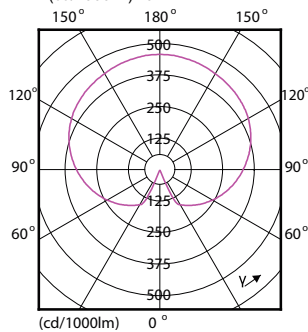
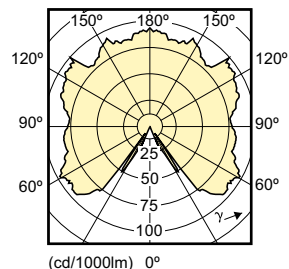
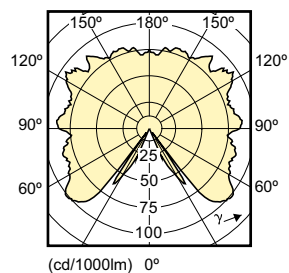

MASTER LEDbulb Glühlampenform

