



MASTER Value LEDspot MV, en optimal kombination av värde och prestanda, passar perfekt för spotbelysning

MASTER VALUE LEDspot MV

MASTER VALUE passar perfekt för spotbelysning och ger ett varmt, halogenliknande accentflöde. Tack vare hög CRI ger den mer naturliga färger, vilket skapar mysiga och bekväma miljöer för bostads- och hotellprojekt och kan även framhäva produkter i butik. Dessa LED-spottar MV GU10 ger den välbekanta känslan av spotbelysning, behåller skönheten i glasspottar och lägger till prestanda för LED-teknik. Med dimringsfunktionen kan du skapa den atmosfär du vill ha och den fungerar med många olika dimmers. MASTER VALUE ger också större energibesparingar än vanliga LED-spottar.

Fördelar

- MASTER VALUE-spotlight ger upp till 80 % lägre energiförbrukning jämfört med halogenlampor
- Bästa efterföljaren till en halogenspotlight för en varm stämning
- Perfekt ersättning för traditionella GU10-ljuskällor

MASTER VALUE LEDspot MV

Funktioner

- Dimbar
- Kompatibel med ett stort urval av dimmerenheter
- Patenterat intelligent driftdon
- 25 000 timmars livslängd
- Ljuset är helt fritt från UV- och IR-strålar och är därför lämpligt för belysning av värmekänsliga föremål (livsmedel, organiskt material, målningar osv.)

Användning

- Hotell och restaurang
- Butiker
- Bostadsområden

Varning och Säkerhet

- Omgivningstemperaturen vid drift ligger mellan -20°C och 45°C
- Endast för användning i torra eller fuktiga miljöer och i de flesta öppna armaturer med lamphållare med tillräckligt stort luftutrymme (minst 10 mm)
- Ej avsedd för användning i nödljusarmaturer eller utgångsljus

Versions



LEDspot Corepro GU10 PAR16



LEDspots 50W GU10 PAR16

Måttskiss

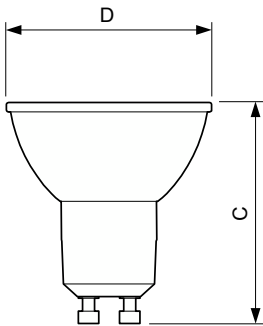

Product	D	C
MAS LED spot VLE D 3.7-35W GU10 930 36D	50 mm	54 mm
MAS LED spot VLE D 3.7-35W GU10 940 36D	50 mm	54 mm
MAS LED spot VLE D 3.7-35W GU10 940 60D	50 mm	54 mm
MAS LED spot VLE D 4.9-50W GU10 927 60D	50 mm	54 mm
MAS LED spot VLE D 4.9-50W GU10 930 36D	50 mm	54 mm
MAS LED spot VLE D 4.9-50W GU10 930 60D	50 mm	54 mm
MAS LED spot VLE D 4.9-50W GU10 940 36D	50 mm	54 mm
MAS LED spot VLE D 4.9-50W GU10 940 60D	50 mm	54 mm
MAS LED spot VLE D 6.2-80W GU10 927 36D	50 mm	54 mm
MAS LED spot VLE D 6.2-80W GU10 930 36D	50 mm	54 mm
MAS LED spot VLE D 6.2-80W GU10 940 36D	50 mm	54 mm
MAS LED spot VLE DT 4.9-50W GU10 927 36D	50 mm	54 mm
MAS LED spot VLE DT 6.2-80W GU10 927 36D	50 mm	56 mm

MASTER VALUE LEDspot MV

Måttskiss

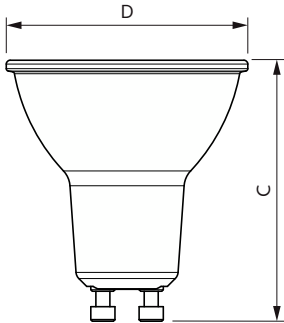

Product	D	C
MAS LED spot VLE D 3.7-35W GU10 927 36D	50 mm	54 mm
MAS LED spot VLE D 3.7-35W GU10 927 60D	50 mm	54 mm
MAS LED spot VLE D 3.7-35W GU10 930 60D	50 mm	54 mm
MAS LED spot VLE D 4.8-50W GU10 927 36D	50 mm	54 mm
MAS LED spot VLE DT 3.7-35W GU10 927 36D	50 mm	54 mm
MAS LEDspot VLE D 4.7-50W GU10 82736D5CT	50 mm	54 mm
MAS LEDspot VLE D 4.7-50W GU10 83036D5CT	50 mm	54 mm

Allmän information

Socket	GU10
Driftcykel	50 000
Nominell livslängd	25 000 h

Ljusteknik

LLMF vid slutet av nominell livslängd (nom)	70 %
---	------

Drift och elektricitet

Ingångsfrekvens	50–60 Hz
Line Frequency	50 to 60 Hz
Tändningstid (nom)	0,5 s

Styrenheter och dimring

Dimbar	Endast med särskilda dimrar
--------	-----------------------------

Mekanik och armaturhus

Lampform	PAR16
----------	-------

Ljusteknik (1/2)

Order Code	Full Product Name	Spridningsvinkel (nom)	Korrelerad		
			färgtemperatur (nom)	Färgåtergivningsindex	Färgkod
929002059502	MAS LED spot VLE D 6.2-80W GU10 927 36D	36 °	2700 K	90	927
929002065902	MAS LED spot VLE DT 6.2-80W GU10 927 36D	36 °	2700 K	90	922-927
929002066002	MAS LED spot VLE D 6.2-80W GU10 940 36D	36 °	4000 K	90	940
929002068402	MAS LED spot VLE D 6.2-80W GU10 930 36D	36 °	3000 K	90	930
929001348302	MAS LED spot VLE D 3.7-35W GU10 930 36D	36 °	3000 K	90	930
929001348402	MAS LED spot VLE D 3.7-35W GU10 940 36D	36 °	4000 K	90	940
929001348702	MAS LED spot VLE D 3.7-35W GU10 940 60D	60 °	4000 K	90	940
929001348902	MAS LED spot VLE D 4.9-50W GU10 930 36D	36 °	3000 K	90	930
929001349002	MAS LED spot VLE D 4.9-50W GU10 940 36D	36 °	4000 K	90	940
929001349102	MAS LED spot VLE D 4.9-50W GU10 927 60D	60 °	2700 K	90	927
929001349202	MAS LED spot VLE D 4.9-50W GU10 930 60D	60 °	3000 K	90	930

MASTER VALUE LEDspot MV

Order Code	Full Product Name	Spridningsvinkel (nom)	Korrelerad		
			färgtemperatur (nom)	Färgåtergivningsindex	Färgkod
929001349302	MAS LED spot VLE D 4.9-50W GU10 940 60D	60 °	4000 K	90	940
929001350302	MAS LED spot VLE DT 4.9-50W GU10 927 36D	36 °	2700 K	90	922-927
929002979402	MAS LED spot VLE D 3.7-35W GU10 927 36D	36 °	2700 K	90	927
929002979702	MAS LED spot VLE DT 3.7-35W GU10 927 36D	36 °	2200 K	90	922-927
929002979802	MAS LED spot VLE D 3.7-35W GU10 927 60D	60 °	2700 K	90	927
929002979902	MAS LED spot VLE D 3.7-35W GU10 930 60D	60 °	3000 K	90	930
929002980102	MAS LED spot VLE D 4.8-50W GU10 927 36D	36 °	2700 K	90	927
929002995452	MAS LEDspot VLE D 4.7-50W GU10 82736D5CT	36 °	2700 K	80	827
929002995552	MAS LEDspot VLE D 4.7-50W GU10 83036D5CT	36 °	3000 K	80	830

Ljusteknik (2/2)

Order Code	Full Product Name	Ljusflöde	Ljusstyrka (nom)	Order Code	Full Product Name	Ljusflöde	Ljusstyrka (nom)
929002059502	MAS LED spot VLE D 6.2-80W GU10 927 36D	575 lm	850 cd	929001349102	MAS LED spot VLE D 4.9-50W GU10 927 60D	355 lm	400 cd
929002065902	MAS LED spot VLE DT 6.2-80W GU10 927 36D	575 lm	950 cd	929001349202	MAS LED spot VLE D 4.9-50W GU10 930 60D	365 lm	400 cd
929002066002	MAS LED spot VLE D 6.2-80W GU10 940 36D	575 lm	850 cd	929001349302	MAS LED spot VLE D 4.9-50W GU10 940 60D	380 lm	400 cd
929002068402	MAS LED spot VLE D 6.2-80W GU10 930 36D	575 lm	850 cd	929001350302	MAS LED spot VLE DT 4.9-50W GU10 927 36D	355 lm	650 cd
929001348302	MAS LED spot VLE D 3.7-35W GU10 930 36D	270 lm	500 cd	929002979402	MAS LED spot VLE D 3.7-35W GU10 927 36D	270 lm	500 cd
929001348402	MAS LED spot VLE D 3.7-35W GU10 940 36D	285 lm	500 cd	929002979702	MAS LED spot VLE DT 3.7-35W GU10 927 36D	270 lm	500 cd
929001348702	MAS LED spot VLE D 3.7-35W GU10 940 60D	285 lm	350 cd	929002979802	MAS LED spot VLE D 3.7-35W GU10 927 60D	270 lm	300 cd
929001348902	MAS LED spot VLE D 4.9-50W GU10 930 36D	365 lm	650 cd	929002979902	MAS LED spot VLE D 3.7-35W GU10 930 60D	270 lm	300 cd
929001349002	MAS LED spot VLE D 4.9-50W GU10 940 36D	380 lm	700 cd	929002980102	MAS LED spot VLE D 4.8-50W GU10 927 36D	355 lm	650 cd

MASTER VALUE LEDspot MV

Order Code	Full Product Name	Ljusflöde	Ljusstyrka (nom)
929002995452	MAS LEDspot VLE D 4.7-50W GU10 82736D5CT	345 lm	650 cd

Order Code	Full Product Name	Ljusflöde	Ljusstyrka (nom)
929002995552	MAS LEDspot VLE D 4.7-50W GU10 83036D5CT	345 lm	650 cd

Drift och elektricitet

Order Code	Full Product Name	Effektförbrukning	Motsvarande effekt
929002059502	MAS LED spot VLE D 6.2-80W GU10 927 36D	6,2 W	80 W
929002065902	MAS LED spot VLE DT 6.2-80W GU10 927 36D	6,2 W	80 W
929002066002	MAS LED spot VLE D 6.2-80W GU10 940 36D	6,2 W	80 W
929002068402	MAS LED spot VLE D 6.2-80W GU10 930 36D	6,2 W	80 W
929001348302	MAS LED spot VLE D 3.7-35W GU10 930 36D	3,7 W	35 W
929001348402	MAS LED spot VLE D 3.7-35W GU10 940 36D	3,7 W	35 W
929001348702	MAS LED spot VLE D 3.7-35W GU10 940 60D	3,7 W	35 W
929001348902	MAS LED spot VLE D 4.9-50W GU10 930 36D	4,9 W	50 W
929001349002	MAS LED spot VLE D 4.9-50W GU10 940 36D	4,9 W	50 W
929001349102	MAS LED spot VLE D 4.9-50W GU10 927 60D	4,9 W	50 W

Order Code	Full Product Name	Effektförbrukning	Motsvarande effekt
929001349202	MAS LED spot VLE D 4.9-50W GU10 930 60D	4,9 W	50 W
929001349302	MAS LED spot VLE D 4.9-50W GU10 940 60D	4,9 W	50 W
929001350302	MAS LED spot VLE DT 4.9-50W GU10 927 36D	4,9 W	50 W
929002979402	MAS LED spot VLE D 3.7-35W GU10 927 36D	3,7 W	35 W
929002979702	MAS LED spot VLE DT 3.7-35W GU10 927 36D	3,7 W	35 W
929002979802	MAS LED spot VLE D 3.7-35W GU10 927 60D	3,7 W	35 W
929002979902	MAS LED spot VLE D 3.7-35W GU10 930 60D	3,7 W	35 W
929002980102	MAS LED spot VLE D 4.8-50W GU10 927 36D	4,8 W	50 W
929002995452	MAS LEDspot VLE D 4.7-50W GU10 82736D5CT	4,7 W	50 W
929002995552	MAS LEDspot VLE D 4.7-50W GU10 83036D5CT	4,7 W	50 W

Temperatur

Order Code	Full Product Name	T-Case max. (nom)
929002059502	MAS LED spot VLE D 6.2-80W GU10 927 36D	80 °C
929002065902	MAS LED spot VLE DT 6.2-80W GU10 927 36D	75 °C
929002066002	MAS LED spot VLE D 6.2-80W GU10 940 36D	80 °C
929002068402	MAS LED spot VLE D 6.2-80W GU10 930 36D	80 °C
929001348302	MAS LED spot VLE D 3.7-35W GU10 930 36D	80 °C
929001348402	MAS LED spot VLE D 3.7-35W GU10 940 36D	80 °C
929001348702	MAS LED spot VLE D 3.7-35W GU10 940 60D	80 °C
929001348902	MAS LED spot VLE D 4.9-50W GU10 930 36D	80 °C
929001349002	MAS LED spot VLE D 4.9-50W GU10 940 36D	80 °C
929001349102	MAS LED spot VLE D 4.9-50W GU10 927 60D	80 °C

Order Code	Full Product Name	T-Case max. (nom)
929001349202	MAS LED spot VLE D 4.9-50W GU10 930 60D	80 °C
929001349302	MAS LED spot VLE D 4.9-50W GU10 940 60D	80 °C
929001350302	MAS LED spot VLE DT 4.9-50W GU10 927 36D	80 °C
929002979402	MAS LED spot VLE D 3.7-35W GU10 927 36D	70 °C
929002979702	MAS LED spot VLE DT 3.7-35W GU10 927 36D	70 °C
929002979802	MAS LED spot VLE D 3.7-35W GU10 927 60D	70 °C
929002979902	MAS LED spot VLE D 3.7-35W GU10 930 60D	70 °C
929002980102	MAS LED spot VLE D 4.8-50W GU10 927 36D	80 °C
929002995452	MAS LEDspot VLE D 4.7-50W GU10 82736D5CT	80 °C
929002995552	MAS LEDspot VLE D 4.7-50W GU10 83036D5CT	80 °C

Användning och godkännande

Order Code	Full Product Name	Energiförbrukning kWh/ 1 000 tim
929002059502	MAS LED spot VLE D 6.2-80W GU10 927 36D	7 kWh
929002065902	MAS LED spot VLE DT 6.2-80W GU10 927 36D	7 kWh

Order Code	Full Product Name	Energiförbrukning kWh/ 1 000 tim
929002066002	MAS LED spot VLE D 6.2-80W GU10 940 36D	7 kWh
929002068402	MAS LED spot VLE D 6.2-80W GU10 930 36D	7 kWh

MASTER VALUE LEDspot MV

Order Code	Full Product Name	Energiförbrukning kWh/ 1 000 tim
929001348302	MAS LED spot VLE D 3.7-35W GU10 930 36D	4 kWh
929001348402	MAS LED spot VLE D 3.7-35W GU10 940 36D	4 kWh
929001348702	MAS LED spot VLE D 3.7-35W GU10 940 60D	4 kWh
929001348902	MAS LED spot VLE D 4.9-50W GU10 930 36D	5 kWh
929001349002	MAS LED spot VLE D 4.9-50W GU10 940 36D	5 kWh
929001349102	MAS LED spot VLE D 4.9-50W GU10 927 60D	5 kWh
929001349202	MAS LED spot VLE D 4.9-50W GU10 930 60D	5 kWh
929001349302	MAS LED spot VLE D 4.9-50W GU10 940 60D	5 kWh
929001350302	MAS LED spot VLE DT 4.9-50W GU10 927 36D	5 kWh
929002979402	MAS LED spot VLE D 3.7-35W GU10 927 36D	4 kWh
929002979702	MAS LED spot VLE DT 3.7-35W GU10 927 36D	4 kWh
929002979802	MAS LED spot VLE D 3.7-35W GU10 927 60D	4 kWh
929002979902	MAS LED spot VLE D 3.7-35W GU10 930 60D	4 kWh
929002980102	MAS LED spot VLE D 4.8-50W GU10 927 36D	5 kWh
929002995452	MAS LEDspot VLE D 4.7-50W GU10 82736D5CT	5 kWh
929002995552	MAS LEDspot VLE D 4.7-50W GU10 83036D5CT	5 kWh

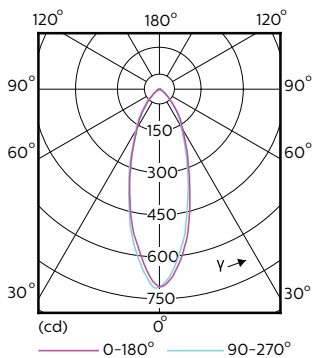
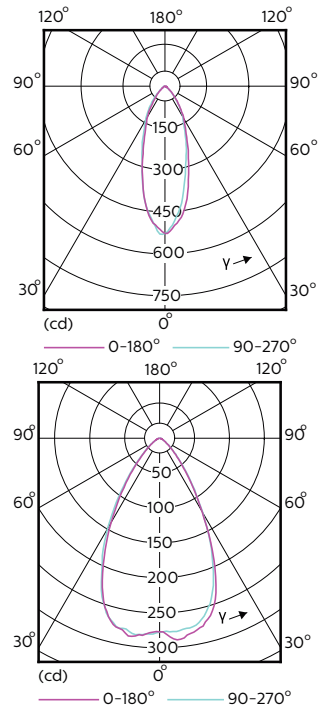

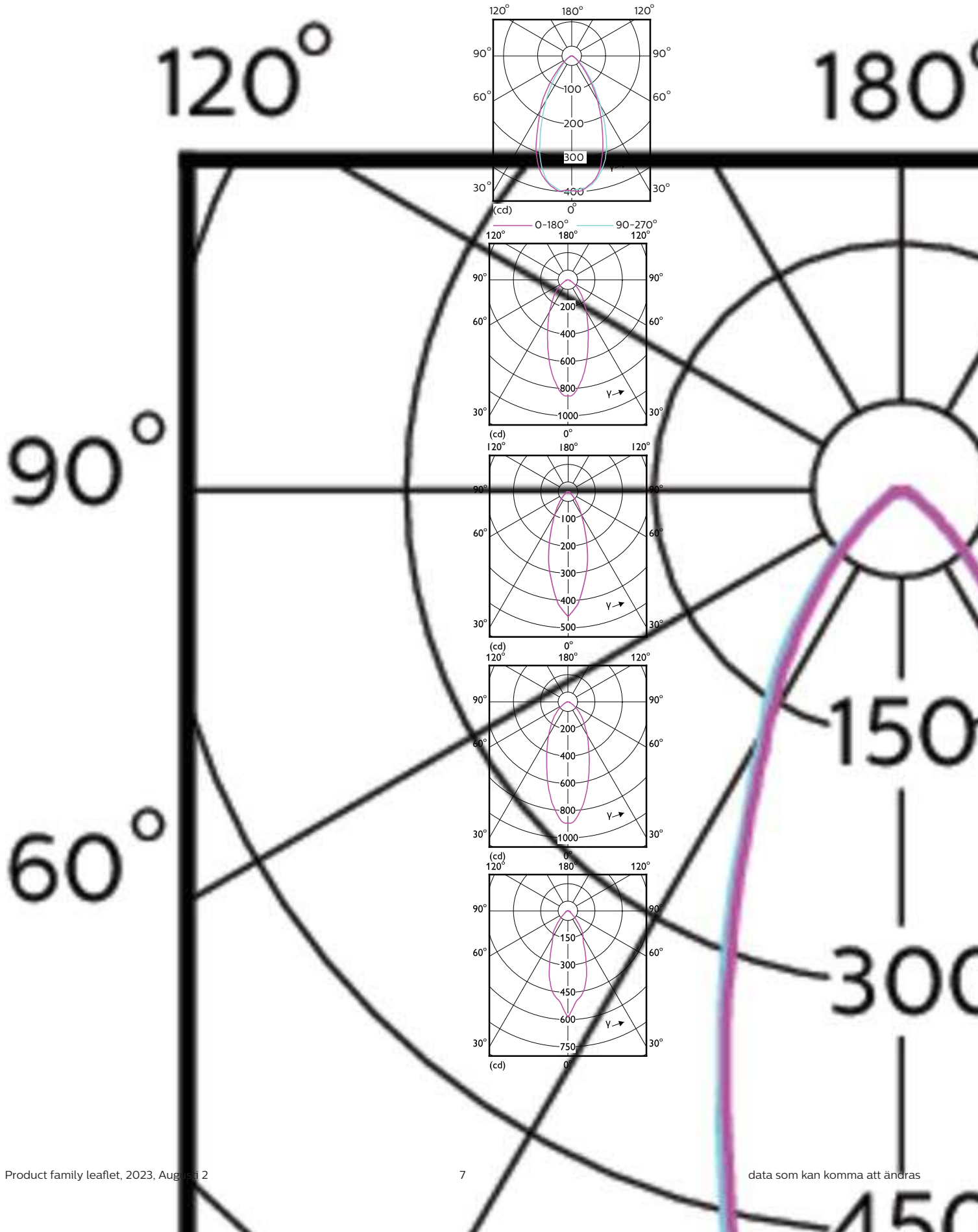

MASTER VALUE LEDspot MV

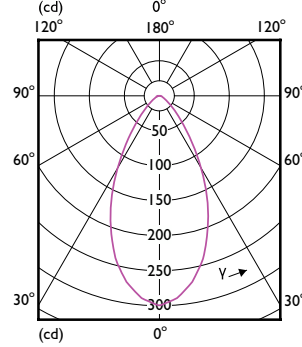
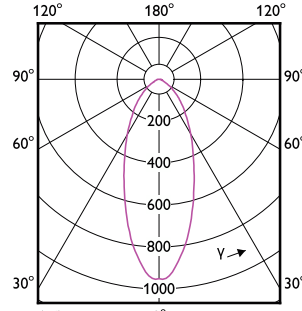
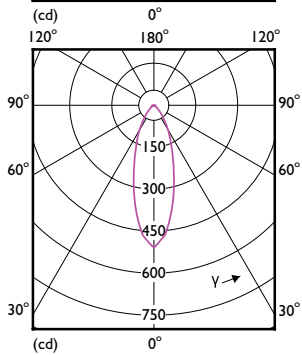
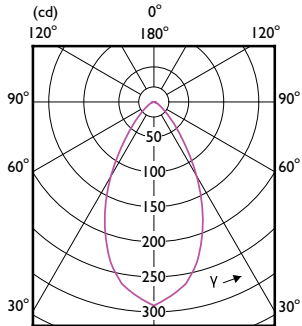
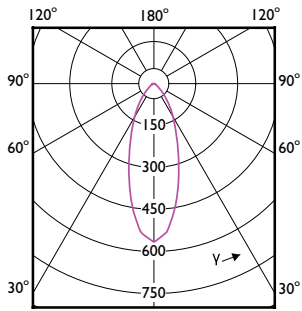

Accent Diagrams

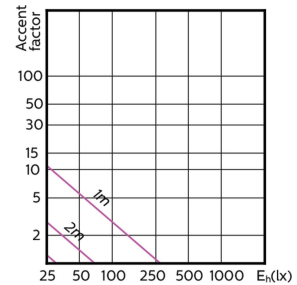
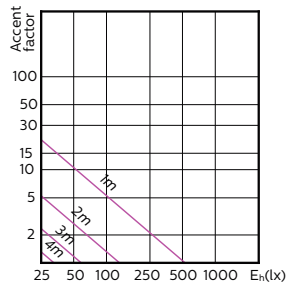
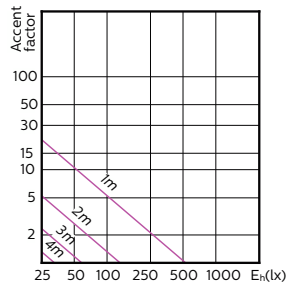

Accent Diagram - MAS LED spot VLE DT
4.9-50W GU10 927 36D

Accent Diagram - MAS LED spot VLE D 3.7-35W
GU10 940 36D

Accent Diagram - MAS LED spot VLE D 3.7-35W
GU10 940 60D

Accent Diagrams

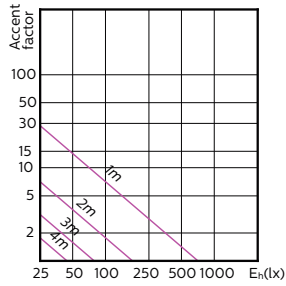

Accent Diagram - MAS LED spot VLE D
4.9-50W GU10 930 36D

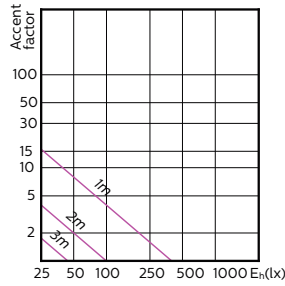

Accent Diagram - MAS LED spot VLE D
4.9-50W GU10 930 60D

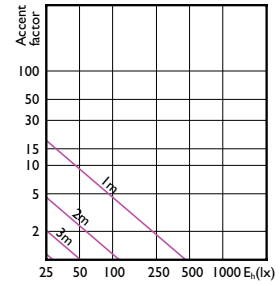

Accent Diagram - MAS LED spot VLE DT
3.7-35W GU10 927 36D

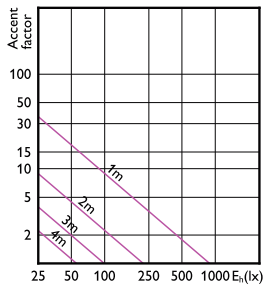

Accent Diagram - MAS LED spot VLE D 6.2-80W
GU10 940 36D

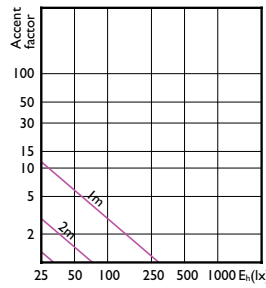

Accent Diagram - MAS LED spot VLE D 3.7-35W
GU10 927 60D

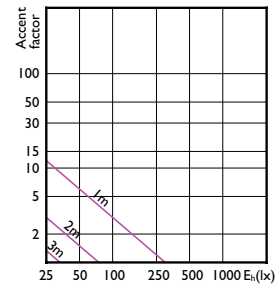

Accent Diagram - MAS LED spot VLE D 3.7-35W
GU10 930 60D

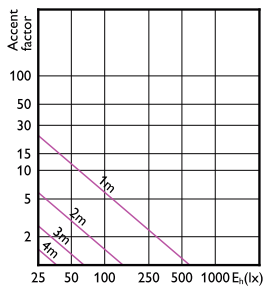

Accent Diagram - MAS LEDspot VLE D 4.7-50W
GU10 82736D5CT

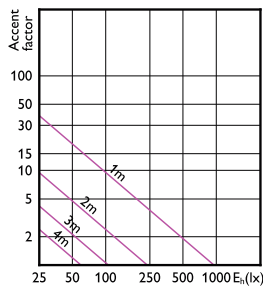

Accent Diagram - MAS LED spot VLE DT
6.2-80W GU10 927 36D

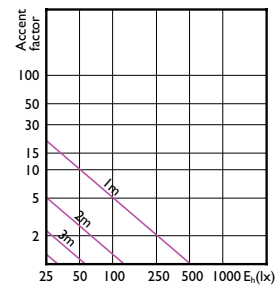

Accent Diagram - MAS LED spot VLE D 3.7-35W
GU10 927 36D

MASTER VALUE LEDspot MV

Accent Diagrams

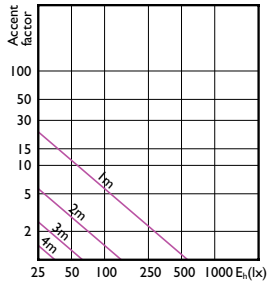

Accent Diagram - MAS LED spot VLE D 4.8-50W
GU10 927 36D

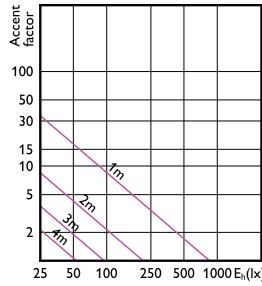

Accent Diagram - MAS LED spot VLE D 6.2-80W
GU10 930 36D

Beam Diagrams

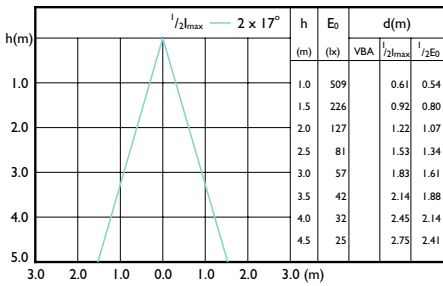

Beam diagram - MAS LED spot VLE D 3.7-35W
GU10 927 36D

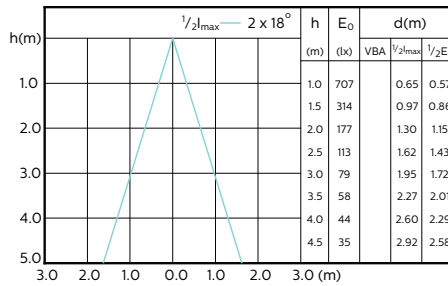

Beam diagram - MAS LED spot VLE DT 4.9-50W
GU10 927 36D

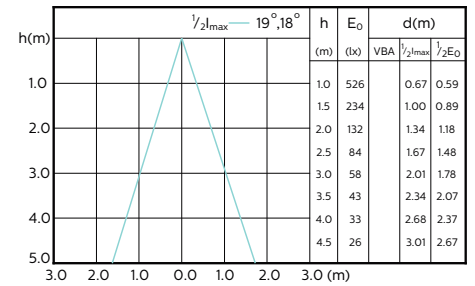

Beam diagram - MAS LED spot VLE D 3.7-35W
GU10 940 36D

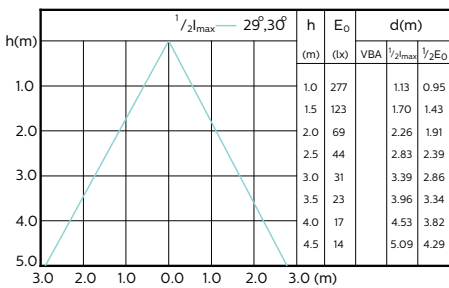

Beam diagram - MAS LED spot VLE D 3.7-35W
GU10 940 60D

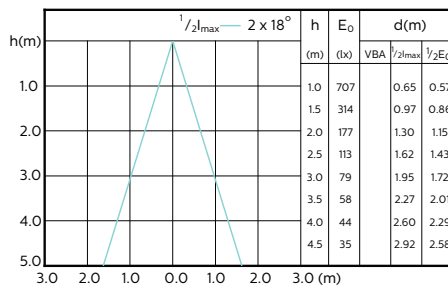

Beam diagram - MAS LED spot VLE D 4.9-50W
GU10 930 36D

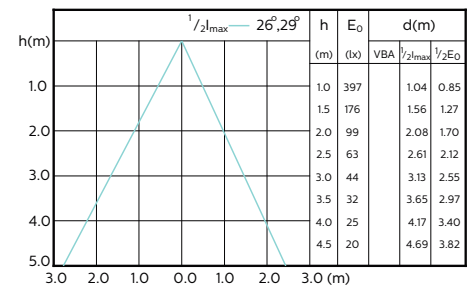

Beam diagram - MAS LED spot VLE D 4.9-50W
GU10 930 60D

Beam Diagrams

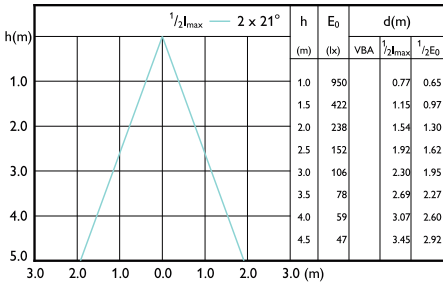

Beam diagram - MAS LED spot VLE DT 6.2-80W GU10 927 36D

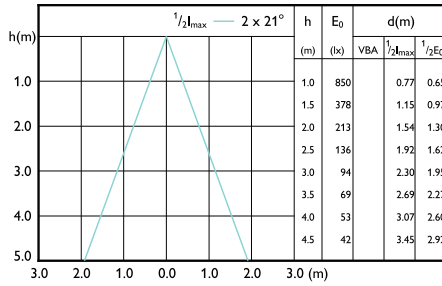

Beam diagram - MAS LED spot VLE D 6.2-80W GU10 930 36D

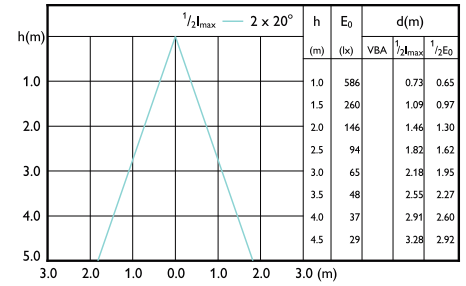

Beam diagram - MAS LEDspot VLE D 4.7-50W GU10 82736D5CT

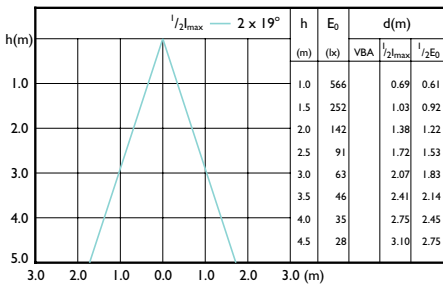

Beam diagram - MAS LED spot VLE D 4.8-50W GU10 927 36D

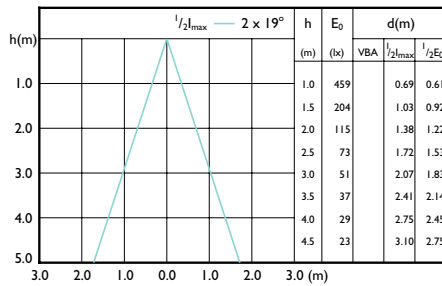

Beam diagram - MAS LED spot VLE DT 3.7-35W GU10 927 36D

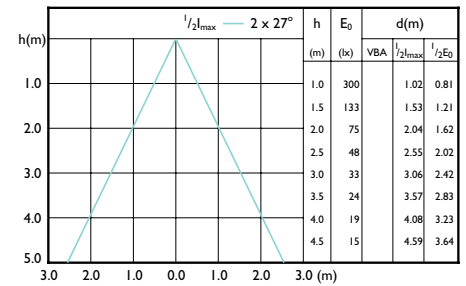

Beam diagram - MAS LED spot VLE D 3.7-35W GU10 930 60D

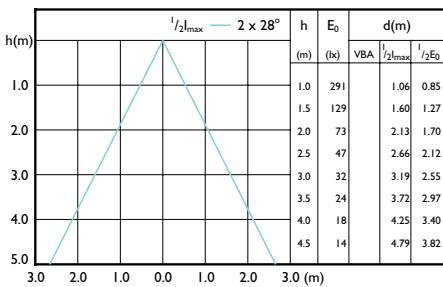

Beam diagram - MAS LED spot VLE D 3.7-35W GU10 927 60D

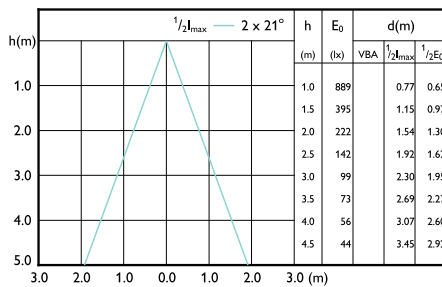

Beam diagram - MAS LED spot VLE D 6.2-80W GU10 940 36D

MASTER VALUE LEDspot MV

