



# The Perfect LED Spot solution

## LED MR16

Philips LED MR-16 lamps with single optic technology provide the look and color quality of traditional halogens while using a fraction of the energy. A perfect fit for spot lighting, they are compatible with most existing fixtures with MR16 GU5.3 holders and are designed as a retrofit replacement for halogen or incandescent spots.

### Benefits

- Up to 80% energy saving compared with halogen lamps and lower maintenance costs
- Easy to replace/retro-fit. Broad compatibility with transformers
- “Perfect fit” in most current Halogen fixtures

### Features

- Ranging between 15,000 to 40,000 hour LED Lifetime
- Easy to replace/retro-fit- “Perfect fit” in most current Halogen fixtures. Title 20 & Title 24 JA8 compliant versions options are available
- Optimized look and feel of product
- Compatible with most commonly available halogen transformers
- Ranging between 3-year to 5-year limited component warranty depending upon operating hours

### Application

- Hotels, restaurants, bars, cafés, museums, shops
- Lobbies, corridors, stairwells, washrooms, reception areas , exhibitions, display cabinets

# LED MR16

## Versions



GU5.3 MR16



GU5.3 MR16



GU5.3 MR16



GU5.3 2inch/50mm Clear

## Dimensional drawing

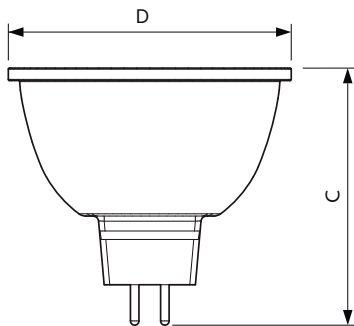
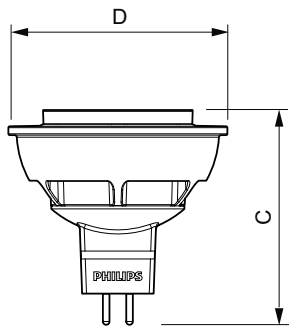

Product	D	C
6.4MR16/F35/3000 DIM 12V	51 mm	51 mm

Product	D	C
8MR16/LED/827/F35/DIM 12V 10/1FB	50 mm	46.5 mm
8MR16/LED/830/F25/DIM 12V 10/1FB	50 mm	46.5 mm
7MR16/LED/830/F25/DIM 12V 10/1FB	50 mm	46.5 mm
6.3MR16/LED/F25/927/D/EC/12V T20 10/1FB	50.5 mm	46 mm
6.3MR16/LED/F35/927/D/EC/12V T20 10/1FB	50.5 mm	46 mm
7.8MR16/PER/940/F25/Dim/EC/12V 10/1FB	50.5 mm	46 mm
7MR16/LED/830/F35/DIM 12V 10/1FB	50 mm	46.5 mm
8MR16/LED/840/F25/DIM 12V 10/1FB	50 mm	46.5 mm
8MR16/LED/827/F25/DIM 12V 10/1FB	50 mm	46.5 mm
8MR16/LED/840/F35/DIM 12V 10/1FB	50 mm	46.5 mm
7.8MR16/PER/930/F25/Dim/EC/12V 10/1FB	50.5 mm	46 mm
7.8MR16/PER/930/F35/Dim/EC/12V 10/1FB	50.5 mm	46 mm
7.8MR16/PER/930/S10/Dim/EC/12V 10/1FB	50.5 mm	46 mm
6.3MR16/LED/F35/930/D/EC/12V T20 10/1FB	50.5 mm	46 mm
7.8MR16/PER/940/S10/Dim/EC/12V 10/1FB	50.5 mm	46 mm
7.8MR16/PER/927/F25/Dim/EC/12V 10/1FB	50.5 mm	46 mm
7.8MR16/PER/927/S10/Dim/EC/12V 10/1FB	50.5 mm	46 mm
7.8MR16/PER/927/F35/Dim/EC/12V 10/1FB	50.5 mm	46 mm
7MR16/LED/827/F25/DIM 12V 10/1FB	50 mm	46.5 mm
6.3MR16/LED/F25/930/D/EC/12V T20 10/1FB	50.5 mm	46 mm
8MR16/LED/830/F35/DIM 12V 10/1FB	50 mm	46.5 mm
7.8MR16/PER/940/F35/Dim/EC/12V 10/1FB	50.5 mm	46 mm
7MR16/LED/827/F35/DIM 12V 10/1FB	50 mm	46.5 mm

# LED MR16

## Dimensional drawing

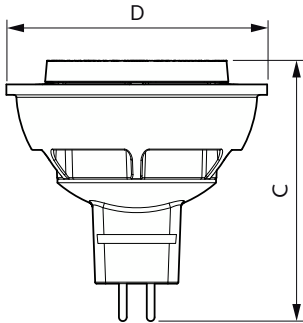

Product	D	C
6.5MR16/F35/2700-2200 DIM 12V	51 mm	50.5 mm
6.5MR16/F25/2700-2200 DIM 12V	51 mm	50.5 mm

### Operating and electrical

Input Frequency	- Hz
-----------------	------

### General information

Cap-Base	GU5.3
Nominal Lifetime (Nom)	25000 h
Switching Cycle	50000

### Light technical

LLmf At End Of Nominal Lifetime (Nom)	70 %
---------------------------------------	------

### Mechanical and housing

Bulb Shape	MR16
------------	------

## Approval and application

Order Code	Full Product Name	Energy Consumption kWh/1000 h
470344	6.4MR16/F35/3000 DIM 12V 10/1	- kWh
573907	8MR16/LED/827/F25/DIM 12V 10/1FB	-
573915	8MR16/LED/830/F25/DIM 12V 10/1FB	-
573931	8MR16/LED/827/F35/DIM 12V 10/1FB	-
573949	8MR16/LED/830/F35/DIM 12V 10/1FB	-
573955	8MR16/LED/840/F35/DIM 12V 10/1FB	-
573865	7MR16/LED/827/F25/DIM 12V 10/1FB	-
573873	7MR16/LED/830/F25/DIM 12V 10/1FB	-
573881	7MR16/LED/827/F35/DIM 12V 10/1FB	-
573899	7MR16/LED/830/F35/DIM 12V 10/1FB	-
573923	8MR16/LED/840/F25/DIM 12V 10/1FB	-
573535	6.3MR16/LED/F25/927/D/EC/12V T20 10/1FB	-
573543	6.3MR16/LED/F25/930/D/EC/12V T20 10/1FB	-

Order Code	Full Product Name	Energy Consumption kWh/1000 h
573550	6.3MR16/LED/F35/927/D/EC/12V T20 10/1FB	-
573568	6.3MR16/LED/F35/930/D/EC/12V T20 10/1FB	-
573576	7.8MR16/PER/927/S10/Dim/EC/12V 10/1FB	-
573584	7.8MR16/PER/930/S10/Dim/EC/12V 10/1FB	-
573592	7.8MR16/PER/940/S10/Dim/EC/12V 10/1FB	-
573600	7.8MR16/PER/927/F25/Dim/EC/12V 10/1FB	-
573618	7.8MR16/PER/930/F25/Dim/EC/12V 10/1FB	-
573626	7.8MR16/PER/940/F25/Dim/EC/12V 10/1FB	-
573634	7.8MR16/PER/927/F35/Dim/EC/12V 10/1FB	-
573642	7.8MR16/PER/930/F35/Dim/EC/12V 10/1FB	-
573659	7.8MR16/PER/940/F35/Dim/EC/12V 10/1FB	-
574400	6.5MR16/F25/2700-2200 DIM 12V	-
574418	6.5MR16/F35/2700-2200 DIM 12V	-

## Controls and dimming

Order Code	Full Product Name	Dimmable
470344	6.4MR16/F35/3000 DIM 12V 10/1	Yes
573907	8MR16/LED/827/F25/DIM 12V 10/1FB	Only with specific dimmers

Order Code	Full Product Name	Dimmable
573915	8MR16/LED/830/F25/DIM 12V 10/1FB	Only with specific dimmers
573931	8MR16/LED/827/F35/DIM 12V 10/1FB	Only with specific dimmers

## LED MR16

Order Code	Full Product Name	Dimmable
573949	8MR16/LED/830/F35/DIM 12V 10/1FB	Only with specific dimmers
573955	8MR16/LED/840/F35/DIM 12V 10/1FB	Only with specific dimmers
573865	7MR16/LED/827/F25/DIM 12V 10/1FB	Only with specific dimmers
573873	7MR16/LED/830/F25/DIM 12V 10/1FB	Only with specific dimmers
573881	7MR16/LED/827/F35/DIM 12V 10/1FB	Only with specific dimmers
573899	7MR16/LED/830/F35/DIM 12V 10/1FB	Only with specific dimmers
573923	8MR16/LED/840/F25/DIM 12V 10/1FB	Only with specific dimmers
573535	6.3MR16/LED/F25/927/D/EC/12V T20 10/1FB	Only with specific dimmers
573543	6.3MR16/LED/F25/930/D/EC/12V T20 10/1FB	Only with specific dimmers
573550	6.3MR16/LED/F35/927/D/EC/12V T20 10/1FB	Only with specific dimmers
573568	6.3MR16/LED/F35/930/D/EC/12V T20 10/1FB	Only with specific dimmers

Order Code	Full Product Name	Dimmable
573576	7.8MR16/PER/927/S10/Dim/EC/12V 10/1FB	Only with specific dimmers
573584	7.8MR16/PER/930/S10/Dim/EC/12V 10/1FB	Only with specific dimmers
573592	7.8MR16/PER/940/S10/Dim/EC/12V 10/1FB	Only with specific dimmers
573600	7.8MR16/PER/927/F25/Dim/EC/12V 10/1FB	Only with specific dimmers
573618	7.8MR16/PER/930/F25/Dim/EC/12V 10/1FB	Only with specific dimmers
573626	7.8MR16/PER/940/F25/Dim/EC/12V 10/1FB	Only with specific dimmers
573634	7.8MR16/PER/927/F35/Dim/EC/12V 10/1FB	Only with specific dimmers
573642	7.8MR16/PER/930/F35/Dim/EC/12V 10/1FB	Only with specific dimmers
573659	7.8MR16/PER/940/F35/Dim/EC/12V 10/1FB	Only with specific dimmers
574400	6.5MR16/F25/2700-2200 DIM 12V	Only with specific dimmers
574418	6.5MR16/F35/2700-2200 DIM 12V	Only with specific dimmers

### Operating and electrical

Order Code	Full Product Name	Voltage (Nom)	Wattage Equivalent	Power (Nom)	Starting Time (Nom)
470344	6.4MR16/F35/3000 DIM 12V 10/1	12 V	42 W	6.4 W	0.6 s
573907	8MR16/LED/827/F25/DI M 12V 10/1FB	ac electronic 12 V	75 W	8 W	0.5 s
573915	8MR16/LED/830/F25/DI M 12V 10/1FB	ac electronic 12 V	75 W	8 W	0.5 s
573931	8MR16/LED/827/F35/DI M 12V 10/1FB	ac electronic 12 V	75 W	8 W	0.5 s
573949	8MR16/LED/830/F35/DI M 12V 10/1FB	ac electronic 12 V	75 W	8 W	0.5 s
573955	8MR16/LED/840/F35/D IM 12V 10/1FB	ac electronic 12 V	75 W	8 W	0.5 s
573865	7MR16/LED/827/F25/DI M 12V 10/1FB	ac electronic 12 V	50 W	7 W	0.5 s
573873	7MR16/LED/830/F25/DI M 12V 10/1FB	ac electronic 12 V	50 W	7 W	0.5 s
573881	7MR16/LED/827/F35/DI M 12V 10/1FB	ac electronic 12 V	50 W	7 W	0.5 s
573899	7MR16/LED/830/F35/DI M 12V 10/1FB	ac electronic 12 V	50 W	7 W	0.5 s
573923	8MR16/LED/840/F25/D IM 12V 10/1FB	ac electronic 12 V	75 W	8 W	0.5 s
573535	6.3MR16/LED/ F25/927/D/EC/12V T20 10/1FB	ac electronic 12 V	42 W	6.3 W	0.5 s
573543	6.3MR16/LED/ F25/930/D/EC/12V T20 10/1FB	ac electronic 12 V	42 W	6.3 W	0.5 s

Order Code	Full Product Name	Voltage (Nom)	Wattage Equivalent	Power (Nom)	Starting Time (Nom)
573550	6.3MR16/LED/ F35/927/D/EC/12V T20 10/1FB	ac electronic 12 V	42 W	6.3 W	0.5 s
573568	6.3MR16/LED/ F35/930/D/EC/12V T20 10/1FB	ac electronic 12 V	42 W	6.3 W	0.5 s
573576	7.8MR16/PER/927/S10/ Dim/EC/12V 10/1FB	ac electronic 12 V	35 W	7.8 W	0.5 s
573584	7.8MR16/PER/930/S10/ Dim/EC/12V 10/1FB	ac electronic 12 V	35 W	7.8 W	0.5 s
573592	7.8MR16/PER/940/S10/ Dim/EC/12V 10/1FB	ac electronic 12 V	35 W	7.8 W	0.5 s
573600	7.8MR16/PER/927/F25/ Dim/EC/12V 10/1FB	ac electronic 12 V	50 W	7.8 W	0.5 s
573618	7.8MR16/PER/930/F25/ Dim/EC/12V 10/1FB	ac electronic 12 V	50 W	7.8 W	0.5 s
573626	7.8MR16/PER/940/F25/ Dim/EC/12V 10/1FB	ac electronic 12 V	50 W	7.8 W	0.5 s
573634	7.8MR16/PER/927/F35/ Dim/EC/12V 10/1FB	ac electronic 12 V	50 W	7.8 W	0.5 s
573642	7.8MR16/PER/930/F35/ Dim/EC/12V 10/1FB	ac electronic 12 V	50 W	7.8 W	0.5 s
573659	7.8MR16/PER/940/F35/ Dim/EC/12V 10/1FB	ac electronic 12 V	50 W	7.8 W	0.5 s
574400	6.5MR16/ F25/2700-2200 DIM 12V	ac electronic 12 V	35 W	6.5 W	0.5 s
574418	6.5MR16/ F35/2700-2200 DIM 12V	ac electronic 12 V	35 W	6.5 W	0.5 s

### Light technical

Order Code	Full Product Name	Beam Angle (Nom)	Color Code	Correlated Color Temperature (Nom)	Color Rendering Index (Nom)	Luminous Flux (Nom)	Luminous Intensity (Nom)
470344	6.4MR16/F35/3000 DIM 12V 10/1	35°	830	3000 K	80	450 lm	1000 cd

# LED MR16

Order Code	Full Product Name	Beam Angle		Correlated Color		Color Rendering		Luminous Flux	Luminous Intensity
		(Nom)	Color Code	Temperature (Nom)	Index (Nom)	(Nom)	(Nom)		
573907	8MR16/LED/827/F25/DIM 12V 10/1FB	25 °	827	2700 K	80	600 lm	3100 cd		
573915	8MR16/LED/830/F25/DIM 12V 10/1FB	25 °	830	3000 K	80	620 lm	3250 cd		
573931	8MR16/LED/827/F35/DIM 12V 10/1FB	35 °	827	2700 K	80	600 lm	1700 cd		
573949	8MR16/LED/830/F35/DIM 12V 10/1FB	35 °	830	3000 K	80	620 lm	1700 cd		
573955	8MR16/LED/840/F35/DIM 12V 10/1FB	35 °	841	4000 K	80	660 lm	1800 cd		
573865	7MR16/LED/827/F25/DIM 12V 10/1FB	25 °	827	2700 K	80	515 lm	2400 cd		
573873	7MR16/LED/830/F25/DIM 12V 10/1FB	25 °	830	3000 K	80	515 lm	2500 cd		
573881	7MR16/LED/827/F35/DIM 12V 10/1FB	35 °	827	2700 K	80	515 lm	1350 cd		
573899	7MR16/LED/830/F35/DIM 12V 10/1FB	35 °	830	3000 K	80	515 lm	1350 cd		
573923	8MR16/LED/840/F25/DIM 12V 10/1FB	25 °	841	4000 K	80	660 lm	3350 cd		
573535	6.3MR16/LED/F25/927/D/EC/12V T20 10/1FB	25 °	927	2700 K	91	470 lm	1960 cd		
573543	6.3MR16/LED/F25/930/D/EC/12V T20 10/1FB	25 °	930	3000 K	91	470 lm	1960 cd		
573550	6.3MR16/LED/F35/927/D/EC/12V T20 10/1FB	35 °	927	2700 K	91	470 lm	1110 cd		
573568	6.3MR16/LED/F35/930/D/EC/12V T20 10/1FB	35 °	930	3000 K	91	470 lm	1110 cd		
573576	7.8MR16/PER/927/S10/Dim/EC/12V 10/1FB	10 °	927	2700 K	95	480 lm	5300 cd		
573584	7.8MR16/PER/930/S10/Dim/EC/12V 10/1FB	10 °	930	3000 K	95	480 lm	5300 cd		
573592	7.8MR16/PER/940/S10/Dim/EC/12V 10/1FB	10 °	940	4000 K	95	540 lm	5900 cd		
573600	7.8MR16/PER/927/F25/Dim/EC/12V 10/1FB	25 °	927	2700 K	95	480 lm	2330 cd		
573618	7.8MR16/PER/930/F25/Dim/EC/12V 10/1FB	25 °	930	3000 K	95	480 lm	2330 cd		
573626	7.8MR16/PER/940/F25/Dim/EC/12V 10/1FB	25 °	940	4000 K	95	540 lm	2600 cd		
573634	7.8MR16/PER/927/F35/Dim/EC/12V 10/1FB	35 °	927	2700 K	95	480 lm	1320 cd		
573642	7.8MR16/PER/930/F35/Dim/EC/12V 10/1FB	35 °	930	3000 K	95	480 lm	1320 cd		
573659	7.8MR16/PER/940/F35/Dim/EC/12V 10/1FB	35 °	940	4000 K	95	540 lm	1450 cd		
574400	6.5MR16/F25/2700-2200 DIM 12V	25 °	822-827	2200, 2700 K	80	455 lm	1601 cd		
574418	6.5MR16/F35/2700-2200 DIM 12V	35 °	822-827	2200, 2700 K	80	455 lm	950 cd		

## Mechanical and housing

Order Code	Full Product Name	Bulb Finish	Order Code	Full Product Name	Bulb Finish
470344	6.4MR16/F35/3000 DIM 12V 10/1	Frosted	573550	6.3MR16/LED/F35/927/D/EC/12V T20 10/1FB	Clear
573907	8MR16/LED/827/F25/DIM 12V 10/1FB	Clear	573568	6.3MR16/LED/F35/930/D/EC/12V T20 10/1FB	Clear
573915	8MR16/LED/830/F25/DIM 12V 10/1FB	Clear	573576	7.8MR16/PER/927/S10/Dim/EC/12V 10/1FB	Clear
573931	8MR16/LED/827/F35/DIM 12V 10/1FB	Clear	573584	7.8MR16/PER/930/S10/Dim/EC/12V 10/1FB	Clear
573949	8MR16/LED/830/F35/DIM 12V 10/1FB	Clear	573592	7.8MR16/PER/940/S10/Dim/EC/12V 10/1FB	Clear
573955	8MR16/LED/840/F35/DIM 12V 10/1FB	Clear	573600	7.8MR16/PER/927/F25/Dim/EC/12V 10/1FB	Clear
573865	7MR16/LED/827/F25/DIM 12V 10/1FB	Clear	573618	7.8MR16/PER/930/F25/Dim/EC/12V 10/1FB	Clear
573873	7MR16/LED/830/F25/DIM 12V 10/1FB	Clear	573626	7.8MR16/PER/940/F25/Dim/EC/12V 10/1FB	Clear
573881	7MR16/LED/827/F35/DIM 12V 10/1FB	Clear	573634	7.8MR16/PER/927/F35/Dim/EC/12V 10/1FB	Clear
573899	7MR16/LED/830/F35/DIM 12V 10/1FB	Clear	573642	7.8MR16/PER/930/F35/Dim/EC/12V 10/1FB	Clear
573923	8MR16/LED/840/F25/DIM 12V 10/1FB	Clear	573659	7.8MR16/PER/940/F35/Dim/EC/12V 10/1FB	Clear
573535	6.3MR16/LED/F25/927/D/EC/12V T20 10/1FB	Clear	574400	6.5MR16/F25/2700-2200 DIM 12V	Clear
573543	6.3MR16/LED/F25/930/D/EC/12V T20 10/1FB	Clear	574418	6.5MR16/F35/2700-2200 DIM 12V	Clear

## Temperature

Order Code	Full Product Name	T-Case Maximum (Nom)	Order Code	Full Product Name	T-Case Maximum (Nom)
470344	6.4MR16/F35/3000 DIM 12V 10/1	100 °C	573949	8MR16/LED/830/F35/DIM 12V 10/1FB	93 °C
573907	8MR16/LED/827/F25/DIM 12V 10/1FB	93 °C	573955	8MR16/LED/840/F35/DIM 12V 10/1FB	93 °C
573915	8MR16/LED/830/F25/DIM 12V 10/1FB	93 °C	573865	7MR16/LED/827/F25/DIM 12V 10/1FB	90 °C
573931	8MR16/LED/827/F35/DIM 12V 10/1FB	93 °C	573873	7MR16/LED/830/F25/DIM 12V 10/1FB	90 °C

## LED MR16

Order Code	Full Product Name	T-Case Maximum (Nom)
573881	7MR16/LED/827/F35/DIM 12V 10/1FB	90 °C
573899	7MR16/LED/830/F35/DIM 12V 10/1FB	90 °C
573923	8MR16/LED/840/F25/DIM 12V 10/1FB	93 °C
573535	6.3MR16/LED/F25/927/D/EC/12V T20 10/1FB	89 °C
573543	6.3MR16/LED/F25/930/D/EC/12V T20 10/1FB	89 °C
573550	6.3MR16/LED/F35/927/D/EC/12V T20 10/1FB	89 °C
573568	6.3MR16/LED/F35/930/D/EC/12V T20 10/1FB	89 °C
573576	7.8MR16/PER/927/S10/Dim/EC/12V 10/1FB	93 °C
573584	7.8MR16/PER/930/S10/Dim/EC/12V 10/1FB	93 °C
573592	7.8MR16/PER/940/S10/Dim/EC/12V 10/1FB	93 °C
573600	7.8MR16/PER/927/F25/Dim/EC/12V 10/1FB	93 °C
573618	7.8MR16/PER/930/F25/Dim/EC/12V 10/1FB	93 °C
573626	7.8MR16/PER/940/F25/Dim/EC/12V 10/1FB	93 °C
573634	7.8MR16/PER/927/F35/Dim/EC/12V 10/1FB	93 °C
573642	7.8MR16/PER/930/F35/Dim/EC/12V 10/1FB	93 °C
573659	7.8MR16/PER/940/F35/Dim/EC/12V 10/1FB	93 °C
574400	6.5MR16/F25/2700-2200 DIM 12V	80 °C
574418	6.5MR16/F35/2700-2200 DIM 12V	80 °C

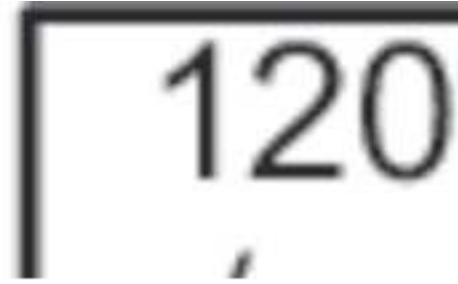

# LED MR16

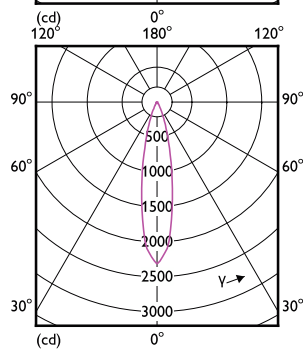
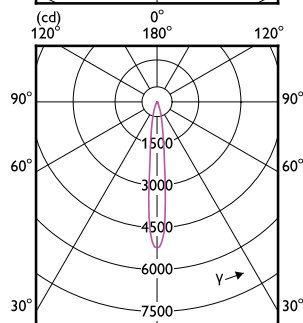
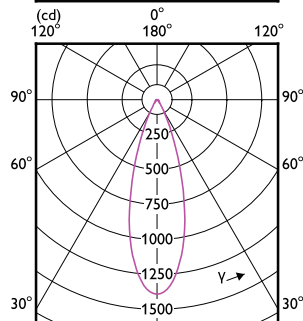
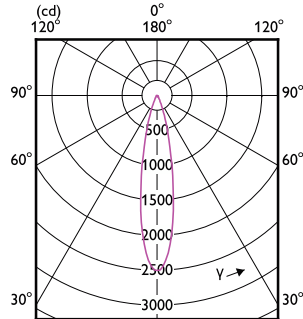
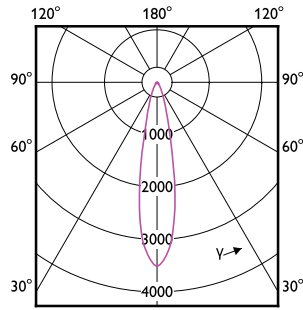
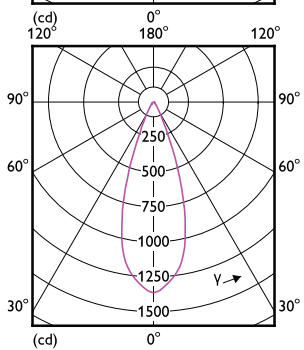
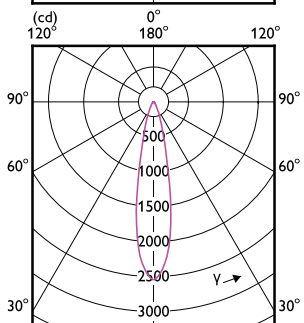
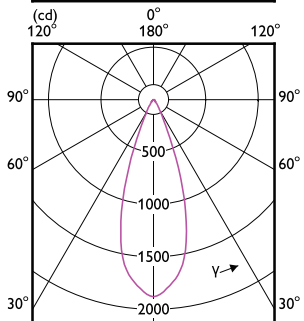
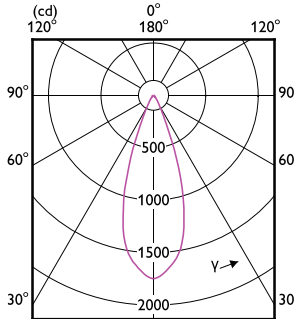
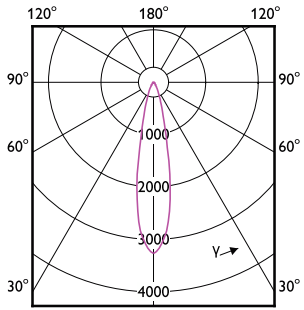

# LED MR16

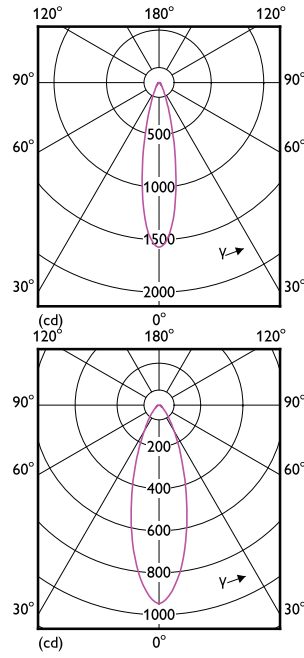
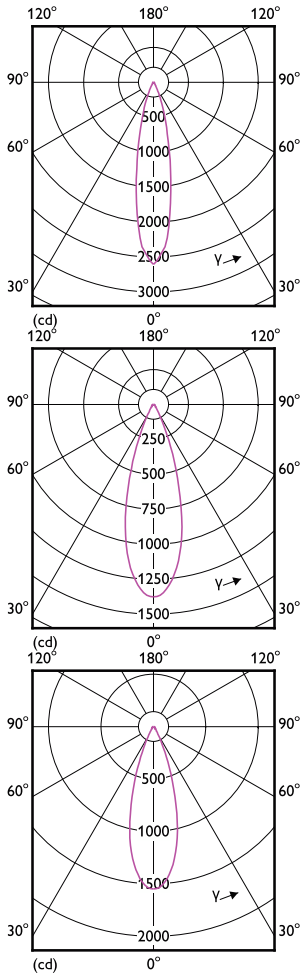

## Accent Diagrams

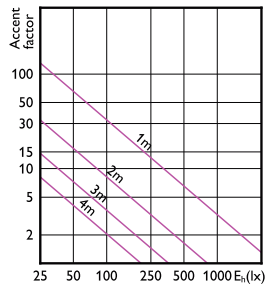

LEDspots DIM IC 8W MR16 GU5,3 827 25D-LA2

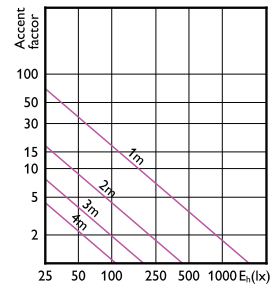

LEDspots DIM IC 8W MR16 GU5,3 827 35D-LA2



# LED MR16

## Accent Diagrams

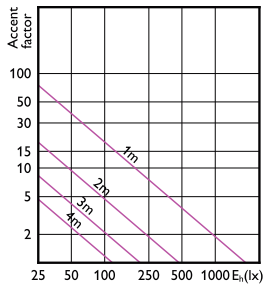

LEDspots DIM IC 8W MR16 GU5,3 840 35D-LA2

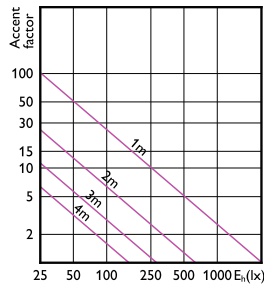

LEDspots DIM IC 7W MR16 GU5,3 827 25D-LA2

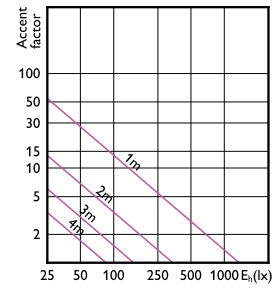

LEDspots DIM IC 7W MR16 GU5,3 827 35D-LA2

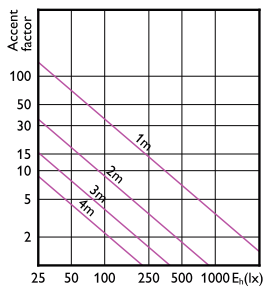

LEDspots DIM IC 8W MR16 GU5,3 840 25D-LA2

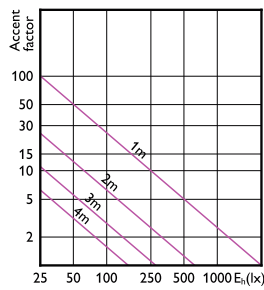

LEDspots DIM IC 6,3W MR16 GU5,3 927 25D-LA2

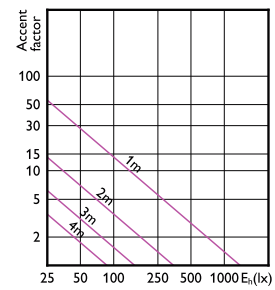

LEDspots DIM IC 6,3W MR16 GU5,3 927 35D-LA2

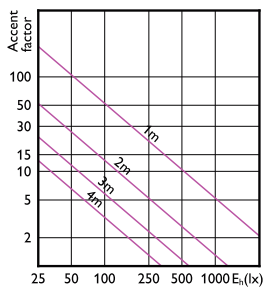

LEDspots DIM IC 7,8W MR16 GU5,3 927 10D-LA2

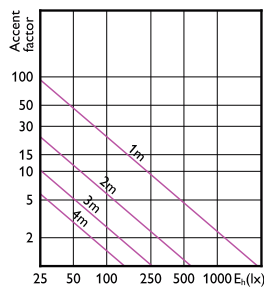

LEDspots DIM IC 7,8W MR16 GU5,3 927 25D-LA2

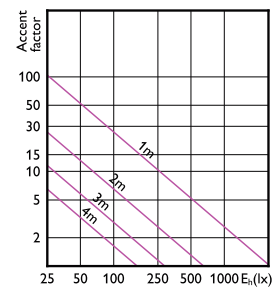

LEDspots DIM IC 7,8W MR16 GU5,3 940 25D-LA2

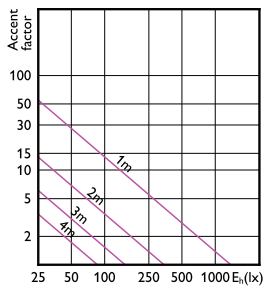

LEDspots DIM IC 7,8W MR16 GU5,3 927 35D-LA2

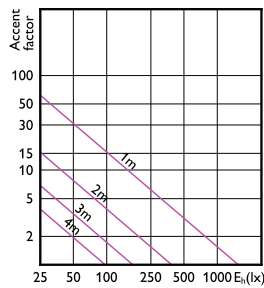

LEDspots DIM IC 7,8W MR16 GU5,3 940 35D-LA2

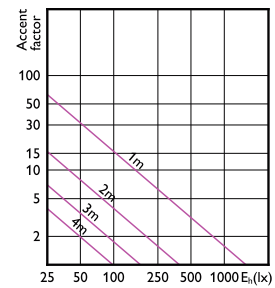

LEDspots DIM IC 6,5W MR16 GU5,3 827 25D-LA2

# LED MR16

## Accent Diagrams

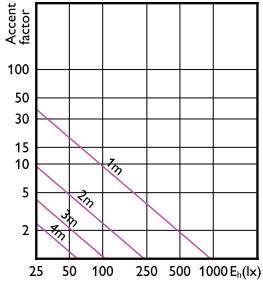

LEDspots DIM IC 6,5W MR16 GU5,3 827 35D-LA2

## Beam Diagrams

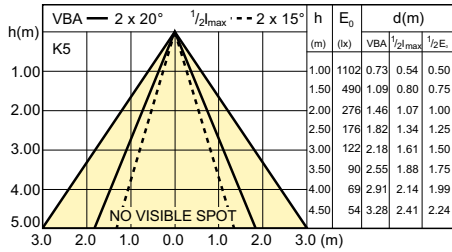

SDBE\_LEDspotL\_0130-Beam diagram

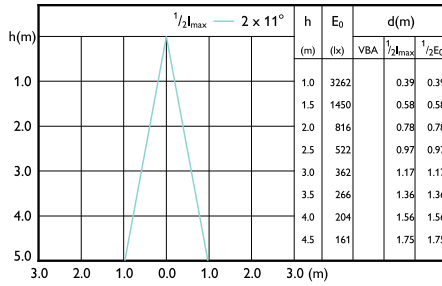

LEDspots DIM IC 8W MR16 GU5,3 827 25D-LBP

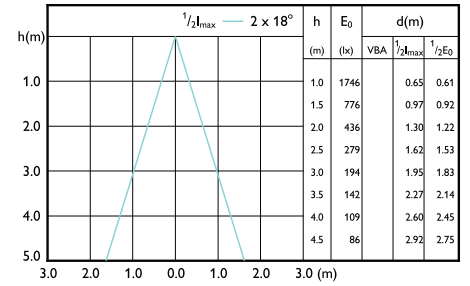

LEDspots DIM IC 8W MR16 GU5,3 827 35D-LBP

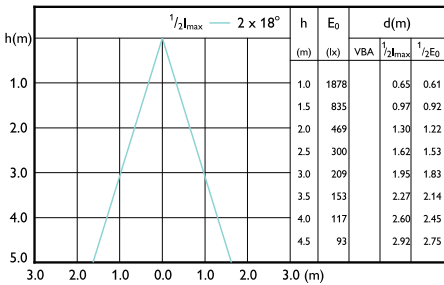

LEDspots DIM IC 8W MR16 GU5,3 840 35D-LBP

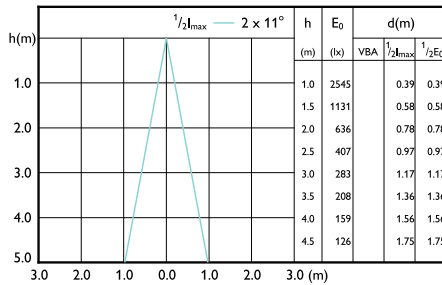

LEDspots DIM IC 7W MR16 GU5,3 827 25D-LBP

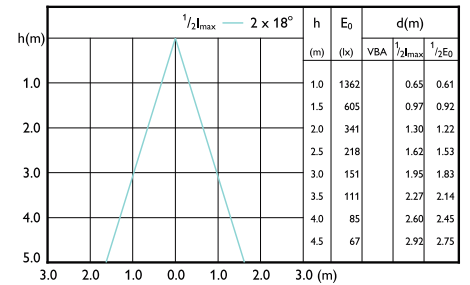

LEDspots DIM IC 7W MR16 GU5,3 827 35D-LBP

# LED MR16

## Beam Diagrams

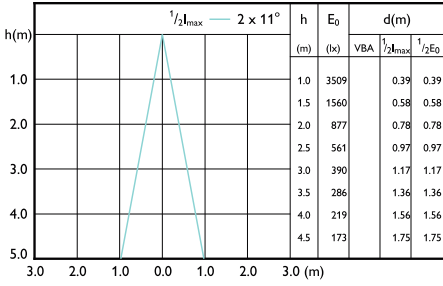

LEDspots DIM IC 8W MR16 GU5,3 840 25D-LBP

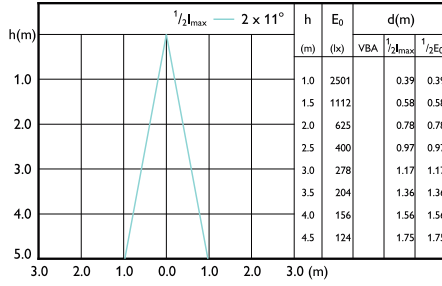

LEDspots DIM IC 6,3W MR16 GU5,3 927 25D-LBP

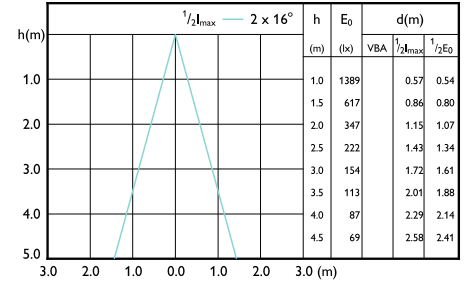

LEDspots DIM IC 6,3W MR16 GU5,3 927 35D-LBP

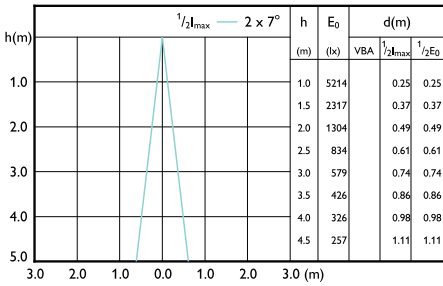

LEDspots DIM IC 7,8W MR16 GU5,3 927 10D-LBP

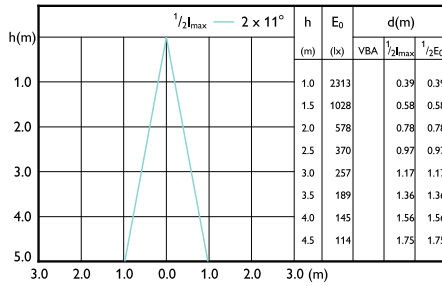

LEDspots DIM IC 7,8W MR16 GU5,3 927 25D-LBP

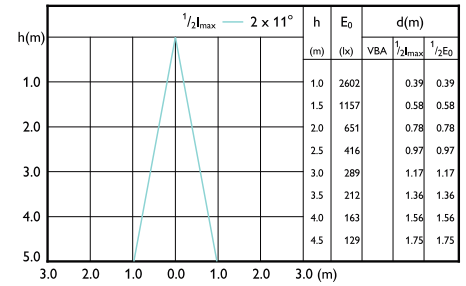

LEDspots DIM IC 7,8W MR16 GU5,3 940 25D-LBP

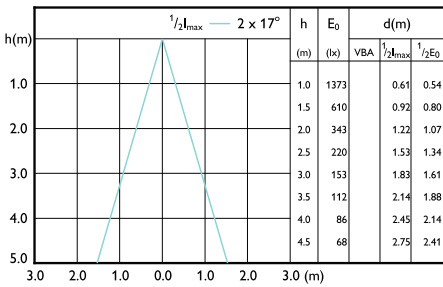

LEDspots DIM IC 7,8W MR16 GU5,3 927 35D-LBP

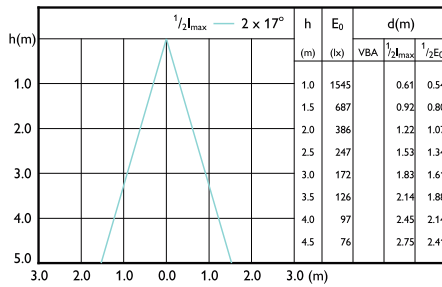

LEDspots DIM IC 7,8W MR16 GU5,3 940 35D-LBP

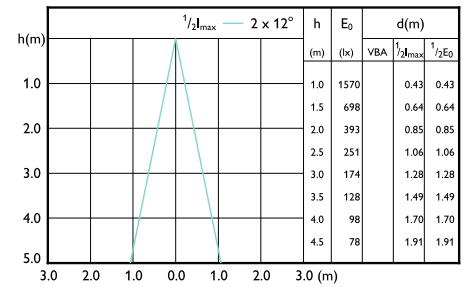

LEDspots DIM IC 6,5W MR16 GU5,3 827 25D-LBP

# LED MR16

## Beam Diagrams

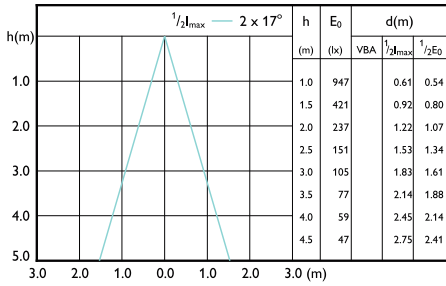

LEDspots DIM IC 6,5W MR16 GU5,3 827 35D-LBP

