



EFix TCS260

TCS260 1x28W/840 HFS M6 SI

EFix surface mounted, 1, 28 W, 840 neutral white, HF Standard, Matt optic double parabolic louver closed, Silver

The EFix TL5 luminaire range is a dedicated, affordable choice of innovative lighting that enables massive energy savings to be made when old electromagnetic installations are replaced by the latest Philips technology. The range's optical performance complies with the latest EN-12464 norms, ensuring improved lighting quality in every application. Used in combination with high-frequency gear, Philips MASTER TL5 lamps enable substantial energy savings to be made. These savings can be further increased by using a Luxsense daylight controller integrated into the luminaire. The practical design of EFix combines both surface-mounted (TCS260) and suspended (TPS262) luminaires in one design. Thanks to the luminaire's easily removable top cover, the beam can be adjusted to provide direct or direct/indirect lighting. EFix is supplied with lamps and is ready to install, minimizing installation time. EFix recessed TBS260 completes Philips' range of luminaires for general lighting applications in offices and shops.

Product data

General Information	
Lamp family code	TL5 [TL5]
Gear	HFS [HF Standard]
Product family code	TCS260 [EFix surface mounted]
Value ladder	Performance
Embedded control	-
CE mark	Yes
Flammability mark	For mounting on normally flammable surfaces

Light Technical	
Number of light sources	1
Light source color	840 neutral white
Optic type	Matt optic double parabolic louver closed
Optical cover type	-

Operating and Electrical	
Input Voltage	220 to 240 V
Power Consumption	28 W

EFix TCS260

Mechanical and Housing

Fixation point length distance (Nom)	1,000 mm
Housing Color	Silver
Overall length	1,241 mm

Approval and Application

Ingress protection code	IP20 [Finger-protected]
Protection class IEC	Safety class I

Application Conditions

Suitable for random switching	Not applicable
-------------------------------	----------------

Product Data

Order product name	TCS260 1x28W/840 HFS M6 SI
Full product name	TCS260 1x28W/840 HFS M6 SI
Full product code	872790061237000
Order code	910402386512
Material Nr. (12NC)	910402386512
Numerator - Quantity Per Pack	1
EAN/UPC - Product/Case	8727900612370
Numerator - Packs per outer box	1
EAN/UPC - Case	8727900612370

Dimensional drawing

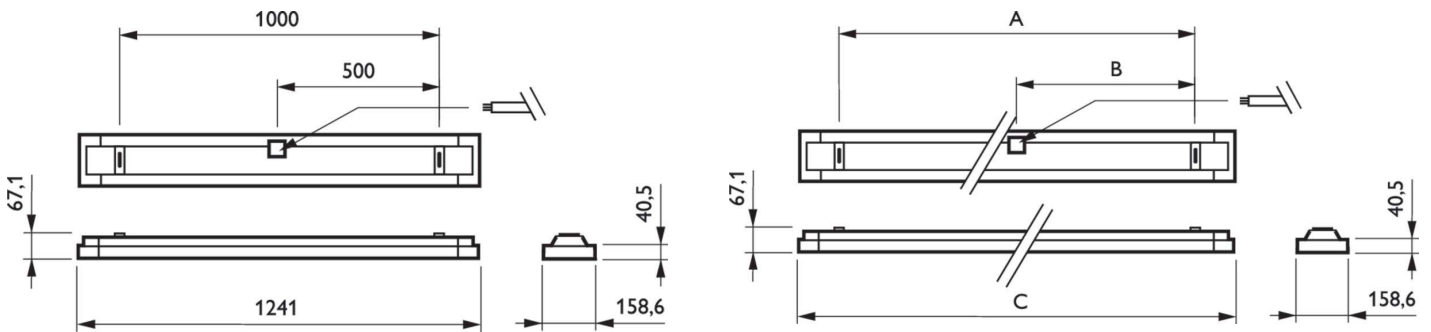

Product	A	B	C
TCS260 1x28W/840 HFS M6 SI	1,000 mm	500 mm	1,241 mm

