



Smart Halogen Downlight QBS020

QBS043 1xMAX50W/12V-GU5.3 WH

1 pc - Max. 50 W - GU5.3 - White

Shop owners opening a new outlet or refurbishing their current installation and contractors looking for attractive propositions for their customers (small/non-chain retailers) now have the ideal solution for impactful, yet affordable accent lighting. Our Smart Halogen Downlight offers customers a choice of different shapes to suit different functions, and the professional finish lends the luminaire an air of contemporary sophistication. Thanks to its robust housing, the Smart Halogen Downlight is a long-lasting solution. Quality clips ensure ease of installation.

Product data

General Information	
Number of light sources	1 [1 pc]
Cap base	GU5.3 [GU5.3]
Flammability mark	F [For mounting on normally flammable surfaces]

Operating and Electrical	
Maximum lamp power	MAX50 [Max. 50 W]
Input voltage	12 V

Approval and Application	
Ingress protection code	IP20 [Finger-protected]

Product Data	
Full product code	910403630290
Order product name	QBS043 1xMAX50W/12V-GU5.3 WH
EAN/UPC – product	6923828687762
Order code	910403630290
Numerator – quantity per pack	1
Numerator – packs per outer box	30
Material no. (12NC)	910403630290
Net weight (piece)	0.220 kg

Smart Halogen Downlight QBS020

Dimensional drawing

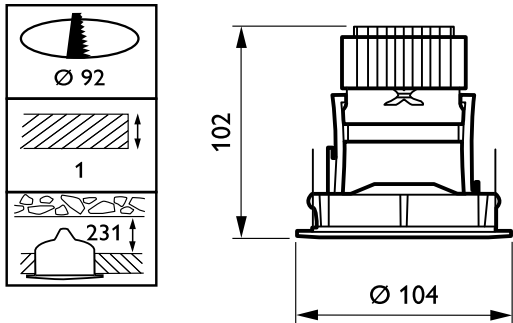

Smart halogen downlight QBS040

