



# Smart Halogen Downlight QBS020

QBS042 1xMAX50W/12V-GU5.3 WH

1 pc - Max. 50 W - GU5.3 - White

Shop owners opening a new outlet or refurbishing their current installation and contractors looking for attractive propositions for their customers (small/non-chain retailers) now have the ideal solution for impactful, yet affordable accent lighting. Our Smart Halogen Downlight offers customers a choice of different shapes to suit different functions, and the professional finish lends the luminaire an air of contemporary sophistication. Thanks to its robust housing, the Smart Halogen Downlight is a long-lasting solution. Quality clips ensure ease of installation.

## Product data

General Information	
Number of light sources	1 [ 1 pc]
Cap base	GU5.3 [ GU5.3]
Flammability mark	F [ For mounting on normally flammable surfaces]

Operating and Electrical	
Maximum lamp power	MAX50 [ Max. 50 W]
Input voltage	12 V

  

Approval and Application	
Ingress protection code	IP20 [ Finger-protected]

Product Data	
Full product code	910403630291
Order product name	QBS042 1xMAX50W/12V-GU5.3 WH
EAN/UPC – product	6923828687748
Order code	910403630291
Numerator – quantity per pack	1
Numerator – packs per outer box	30
Material no. (12NC)	910403630291
Net weight (piece)	0.230 kg

## Smart Halogen Downlight QBS020

### Dimensional drawing

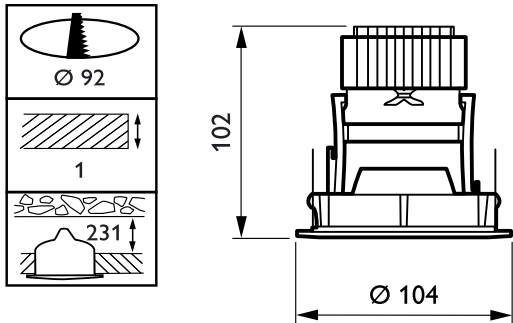

Smart halogen downlight QBS040

