



ColorGraze MX Powercore

BCS459 36xLED-HB/RGB 30 DMX L914

Red, green and blue - 30° x 60° - Medium beam angle 30° - 914 mm - Dynamic DMX

Many architectural structures need a linear fixture capable of illuminating multiple storeys with minimal setback. Property owners/end users need a controllable product capable of dynamic illumination to draw attention to their establishments and emphasize their brands. Graze MX Powercore is capable of illuminating over 20 meters at very close setback distances. Powercore technology enables simple installation and long product run lengths.

Product data

General Information		Operating and Electrical	
Number of light sources	36 [36 pcs]	Input Voltage	100 to 240 V
Lamp family code	LED-HB [LED High Brightness]	Input Frequency	50 to 60 Hz
Light source color	Red, green and blue	Controls and Dimming	
Light source replaceable	No	Dimmable	Yes
Driver included	Yes	Mechanical and Housing	
Optic type	30 [Beam angle 30°]	Length	914 mm
Luminaire light beam spread	30° x 60°	Approval and Application	
Embedded control	DMX [Dynamic DMX]	Ingress protection code	IP66 [Dust penetration-protected, jet-proof]
Protection class IEC	Safety class I (I)	Mech. impact protection code	IK10 [20 J vandal-resistant]
CE mark	CE mark		
UL mark	UL mark		
Lifetime to 70% luminous flux	80000 h		
Optic type outdoor	Medium beam angle 30°		

ColorGraz e MX Powercore

Initial Performance (IEC Compliant)

Initial luminous flux (system flux)	1104 lm
Initial LED luminaire efficacy	16.1 lm/W
Initial input power	52.7 W

Application Conditions

Ambient temperature range	-20 to +50 °C
---------------------------	---------------

Product Data

Full product code	872790071578100
-------------------	-----------------

Order product name	BCS459 36xLED-HB/RGB 30 DMX L914
EAN/UPC - Product	8727900715781
Order code	910503700312
Numerator - Quantity Per Pack	1
Numerator - Packs per outer box	1
Material Nr. (12NC)	910503700312
Net Weight (Piece)	3.400 kg

Dimensional drawing

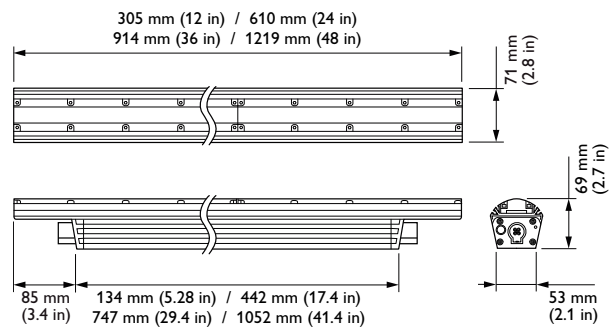
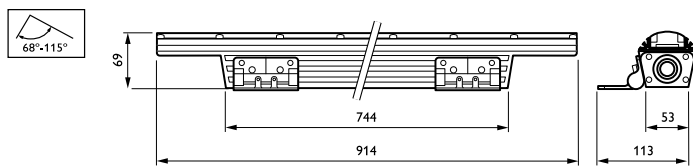

ColorGraz e MX Powercore

ColorGraz e MX Powercore

