



iW Graze MX Powercore

iW Graze MX Powercore, 30° x 60° Beam Angle, 914 mm (3 ft)

iW Graze MX Powercore, 30° x 60° Beam Angle, 914 mm (3 ft)

Many architectural structures need a linear fixture capable of illuminating multiple storeys with minimal setback. Property owners/end users need a controllable product capable of dynamic illumination to draw attention to their establishments and emphasise their brands. Graze MX Powercore is capable of illuminating over 20 meters at very close setback distances. Powercore technology enables simple installation and long product run lengths.

Product data

General information		Controls and dimming	
Lamp family code	LED-HB [LED High Brightness]	Dimmable	Yes
Light source replaceable	No		
Driver included	Yes	Mechanical and housing	
Luminaire light beam spread	30° x 60°	Housing material	Extruded aluminium
Protection class IEC	Safety class I	Optic material	Polycarbonate
CE mark	CE mark	Optical cover/lens material	Polycarbonate
UL mark	UL and cUL mark	Length	914 mm
		Colour	Aluminium
Operating and electrical		Approval and application	
Input Voltage	100 to 277 V	Ingress protection code	IP66 [Dust penetration-protected, jet-proof]
Input frequency	50 to 60 Hz	Mech. impact protection code	IK10 [20 J vandal-resistant]
		Vibration standard	Not compliant to ANSI C136.31, 3G. Special orders are available to conform to the standard.

iW Graze MX Powercore

	Please contact your Color Kinetics Lighting Sales rep for custom configurations.
Vibration rating	Not compliant to ANSI C136.31, 3G. Special orders are available to conform to the standard. Please contact your Color Kinetics Lighting Sales rep for custom configurations.
Initial performance (IEC compliant)	
Initial input power	60 W
Over time performance (IEC compliant)	
Lumen Maintenance 50% at 25 °C Reported	60000
Lumen Maintenance 50% at 50 °C Reported	60000
Lumen Maintenance 70% at 25 °C Reported	60000
Lumen Maintenance 70% at 50 °C Reported	60000

Application conditions

Ambient temperature range	-40 to +50 °C
----------------------------------	---------------

Product data

Full product code	871829160950600
Order product name	BCS429 30x60/2700-6500 L914
EAN/UPC – product	8718291609506
Order code	523-000079-13
SAP numerator – quantity per pack	1
Numerator – packs per outer box	1
SAP material	910503703657
Net Weight (Piece)	3.800 kg
Commercial Code	523-000079-13
Catalogue number description	iW Graze MX Powercore, 30° x 60° Beam Angle, 914 mm (3 ft)



Dimensional drawing

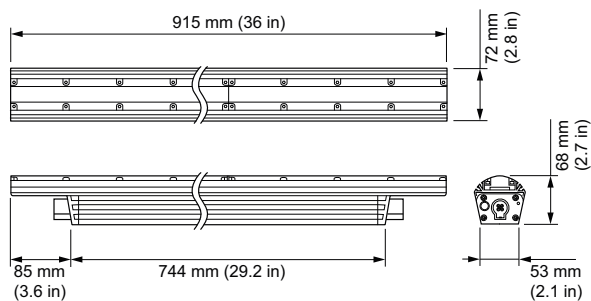

BCS429 30x60/2700-6500 L914

