



Iridium gen3 LED Mini

BGP381 GRN30/740 II MSO CO GR SP

Iridium gen3 Mini - LED GreenLine 3000 lm - 740 neutral white
 - Safety class II (II) - Medium wide street optic - Cover painted - Gray - Spigot

Iridium gen3 is the first truly intelligent luminaire designed for seamless connectivity. No hassle in commissioning – just install the luminaire and control it from a distance through CityTouch management software. Remote light management made easy! The new ‘plug & play’ concept has been designed to ensure safe and easy installation in just three steps: 1. Install the spigot, 2. Plug in the mains, 3. Tilt and close the luminaire. The luminaire’s high efficiency at system level ensures significant energy savings compared to existing conventional installations, offering a fast payback. Thanks to its wide choice of lumen packages, optics and color temperatures, Iridium gen3 fits most applications in residential areas. The luminaire’s neo-classical design guarantees a consistent look and feel for your surroundings.

Product data

General Information		Control interface	
Number of light sources	1 [1 pc]	Control interface	-
Lamp family code	GRN30 [LED GreenLine 3000 lm]	Light regulation	-
Light source colour	740 neutral white	Electrical circuit protection	-
Light source replaceable	Yes	Connection	SI [Screw connection block]
Number of gear units	1 unit	Cable	-
Gear	EB [Electronic]	Protection class IEC	Safety class II (II)
Driver/power unit/transformer	PSR [Power supply unit regulating]	Parts colour	Cover painted
Driver included	Yes	Coating	-
Optical cover/lens type	PC [Polycarbonate bowl/cover]	Glow-wire test	650/5 [Temperature 650 °C, duration 5 s]
Luminaire light beam spread	152°	Flammability mark	NO [-]
Embedded control	No [-]	CE mark	CE mark
		ENEC mark	ENEC mark

Iridium gen3 LED Mini

UL mark	-
Warranty period	5 years
Outdoor optic type	Medium wide street optic
Photocell	No [-]
Gland for mains supply	1PG10 [Cable gland 1x PG 10 mm]
Remarks	*-Per Lighting Europe guidance paper "Evaluating performance of LED based luminaires - January 2018": statistically there is no relevant difference in lumen maintenance between B50 and for example B10. Therefore the median useful life (B50) value also represents the B10 value. * At extreme ambient temperatures the luminaire might automatically dim down to protect components
Constant light output	No
Number of products on MCB	20
RoHS mark	-
LED engine type	LED
Product Family Code	BGP381 [Iridium gen3 Mini]

Light Technical

Upward light output ratio	0
Standard tilt angle post-top	0°
Standard tilt angle side entry	0°

Operating and Electrical

Input voltage	220 to 240 V
Input frequency	50 to 60 Hz
Inrush current	22 A
Inrush time	0.29 ms
Driver current	440 mA
Power factor (min.)	0.95
Power factor (nom.)	0.9

Controls and Dimming

Dimmable	No
----------	----

Mechanical and Housing

Housing material	Aluminum
Reflector material	-
Optic material	Polycarbonate
Optical cover/lens material	Polycarbonate
Fixation material	Aluminum
Mounting device	SP [Spigot]
Optical cover/lens shape	Flat

Optical cover/lens finish	Textured
Overall length	531 mm
Overall width	273 mm
Overall height	156 mm
Effective projected area	0.024 m ²
Colour	Gray

Approval and Application

Ingress protection code	IP66 [Dust penetration-protected, jet-proof]
Mech. impact protection code	IK09 [10 J]
Surge protection (common/differential)	4/4 kV

Initial Performance (IEC Compliant)

Initial luminous flux	2820 lm
Luminous flux tolerance	+/-7%
Initial LED luminaire efficacy	147 lm/W
Init. Corr. colour temperature	4000 K
Init. colour rendering index	70
Initial chromaticity	(0.38, 0.38) SDCM <5
Initial input power	19.2 W
Power consumption tolerance	+/-11%

Over Time Performance (IEC Compliant)

Control gear failure rate at median useful life 100000 h	10 %
Lumen maintenance at median useful life* 100000 h	L80

Application Conditions

Ambient temperature range	-40 to +50 °C
Performance ambient temperature Tq	25 °C
Maximum dimming level	Not applicable

Product Data

Full product code	871829190841800
Order product name	BGP381 GRN30/740 II MSO CO GR SP
EAN/UPC – product	8718291908418
Order code	90841800
Numerator – quantity per pack	1
Numerator – packs per outer box	1
Material no. (12NC)	910925438290
Net weight (piece)	6.850 kg

Iridium gen3 LED Mini

Dimensional drawing

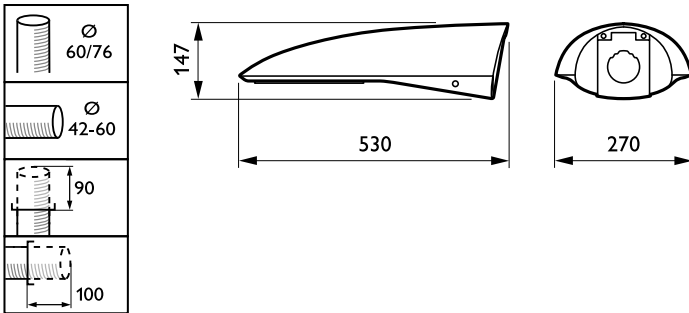

Iridium3 LED BGP381

Photometric data

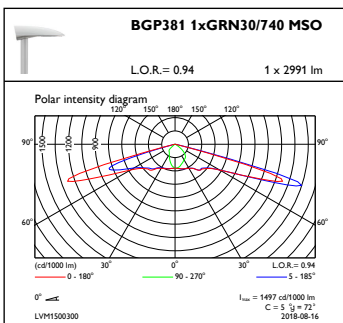

OFPC1_BGP381xGRN30740MSO

