



ClearWay gen2

BGP307 LED109-4S/740 II DM11 CLO-DDF1 D1

ClearWay gen2 - LED module 10900 lm - 740 neutral white - Safety class II - Distribution medium 11 - Universal for diameter 48-60 mm adjustable

ClearWay gen2 enables you to enjoy the benefits of LED technology right from the start. This new second generation of the luminaire builds on the strengths of its predecessor and is designed to further minimise your Total Cost of Ownership. ClearWay gen2 significantly improves the most important aspects of the street lighting experience compared to conventional lighting. Ideal for new streets and for renovating existing installations, this affordable range of lighting solutions combines clean, high-quality light with significant energy and maintenance savings. In short, ClearWay gen2 means good-quality light with all the added benefits of LED – energy savings and long lifetime. Offering more benefits, yet packaged in a thinner and lighter design, which makes it easier to install.

Product data

General Information		Protection class IEC	Safety class II
Lamp family code	LED109 [LED module 10900 lm]	Flammability mark	NO [-]
Light source colour	740 neutral white	CE mark	CE mark
Light source replaceable	Yes	ENEC mark	ENEC mark
Number of gear units	1 unit	Warranty period	5 years
Driver/power unit/transformer	PSU [Power supply unit]	Outdoor optic type	Distribution medium 11
Driver included	Yes	Remarks	*-Per Lighting Europe guidance paper "Evaluating performance of LED based luminaires - January 2018": statistically there is no relevant difference in lumen maintenance between B50 and for example B10. Therefore the median useful life (B50)
Optical cover/lens type	FG [Flat glass]		
Luminaire light beam spread	160° - 42° x 54°		
Control interface	-		
Connection	Push-in connector 5-pole		
Cable	-		

ClearWay gen2

	value also represents the B10 value. * At extreme ambient temperatures the luminaire might automatically dim down to protect components
Constant light output	Programmable
Number of products on MCB	11
RoHS mark	RoHS mark
LED engine type	LED
Product Family Code	BGP307 [ClearWay gen2]

Light Technical

Upward light output ratio	0
Standard tilt angle post-top	0°
Standard tilt angle side entry	0°

Operating and Electrical

Input voltage	220 to 240 V
Input frequency	50 to 60 Hz
Initial CLO power consumption	59 W
Average CLO power consumption	62 W
End CLO power consumption	65 W
Inrush current	46 A
Inrush time	0.25 ms
Power factor (min.)	0.98

Controls and Dimming

Dimmable	yes
----------	-----

Mechanical and Housing

Housing material	Aluminium die-cast
Reflector material	-
Optic material	Polycarbonate
Optical cover/lens material	Tempered glass
Fixation material	Aluminum
Mounting device	48/60A [Universal for diameter 48-60 mm adjustable]
Optical cover/lens shape	Flat
Optical cover/lens finish	Clear
Overall length	480 mm
Overall width	325 mm
Overall height	150 mm

Effective projected area	0.1151 m²
Colour	Grey

Approval and Application

Ingress protection code	IP66 [Dust penetration-protected, jet-proof]
Mech. impact protection code	IK08 [5 J vandal-protected]
Surge protection (common/differential)	Philips standard surge protection level kV

Initial Performance (IEC Compliant)

Initial luminous flux	8428 lm
Luminous flux tolerance	+/-7%
Initial LED luminaire efficacy	143 lm/W
Init. Corr. colour temperature	4000 K
Init. colour rendering index	70
Initial chromaticity	(0.38, 0.38) SDCM <5
Initial input power	65 W
Power consumption tolerance	+/-11%

Over Time Performance (IEC Compliant)

Control gear failure rate at median useful life 100000 h	10 %
Lumen maintenance at median useful life* 100000 h	L100

Application Conditions

Ambient temperature range	-40 to +50 °C
Performance ambient temperature Tq	25 °C
Maximum dimming level	0% (digital)

Product Data

Full product code	871869699726000
Order product name	BGP307 LED109-4S/740 II DM11 CLO-DDF1 D1
EAN/UPC – product	8718696997260
Order code	99726000
Numerator – quantity per pack	1
Numerator – packs per outer box	1
Material no. (12NC)	910925865248
Net weight (piece)	6.320 kg

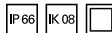

ClearWay gen2

Dimensional drawing

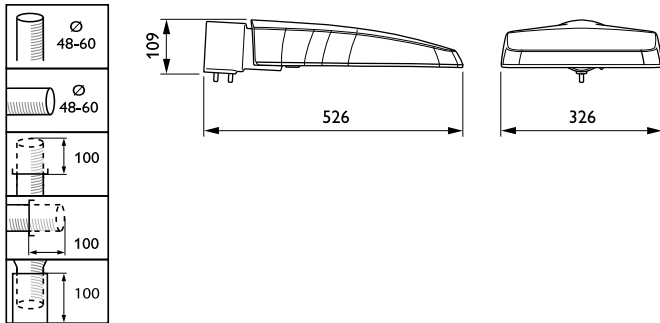

ClearWay gen2 BGP307

