



LuxSpace G4

DN593B LED30/830 PSU C D200 WH WB GM

Reflector

LuxSpace Gen4 is the a new LED downlight range combining light comfort and leading performance with luxury looking

Product data

General Information	
Light source color	830 warm white
Light source replaceable	No
Number of gear units	1 unit
Driver/power unit/transformer	Power supply unit external
Driver included	Yes
Optic type	Facetted reflector with beam angle 60°
Optical cover/lens type	Reflector
Connection	Push-in connector with 2 poles and pull relief
Protection class IEC	Safety class II
Glow-wire test	Temperature 650 °C, duration 30 s
Flammability mark	For mounting on normally flammable surfaces
CE mark	CE mark
Warranty period	3 years
Constant light output	No
Number of products on MCB of 16 A type B	32
RoHS mark	RoHS mark
Operating and Electrical	
Input Voltage	220 to 240 V

Input Frequency	50 or 60 Hz
Inrush current	14.5 A
Inrush time	0.22 ms
Power Factor (Min)	0.9
Controls and Dimming	
Dimmable	No
Mechanical and Housing	
Housing Material	Aluminum die cast
Reflector material	Polycarbonate aluminum coated
Optic material	Polycarbonate
Optical cover/lens material	Polycarbonate
Fixation material	Steel
Optical cover/lens finish	Textured
Overall height	130 mm
Overall diameter	212 mm
Color	White and black
Approval and Application	
Ingress protection code	IP20 [Finger-protected]

LuxSpace G4

Mech. impact protection code	IK03 [0.3 J]
Initial Performance (IEC Compliant)	
Initial luminous flux (system flux)	3300 lm
Luminous flux tolerance	+/-10%
Initial LED luminaire efficacy	102 lm/W
Init. Corr. Color Temperature	3000 K
Init. Color Rendering Index	>80
Initial input power	32.5 W
Power consumption tolerance	+/-10%
Over Time Performance (IEC Compliant)	
Median useful life L70B50	50000 h
Median useful life L80B50	50000 h
Median useful life L90B50	21000 h

Application Conditions

Ambient temperature range	-20 to +40 °C
Maximum dim level	Not applicable

Product Data

Full product code	911401548341
Order product name	DN593B LED30/830 PSU C D200 WH WB GM
Order code	911401548341
Numerator - Quantity Per Pack	1
Numerator - Packs per outer box	1
Material Nr. (12NC)	911401548341
Net Weight (Piece)	1.399 kg

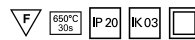

Dimensional drawing

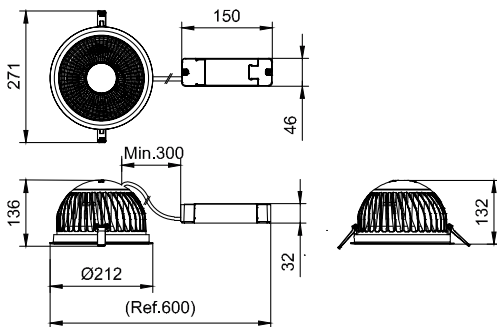

DN58XB/DN59XB

