



LuxSpace G4

DN593B LED30/840 PSD C D200 WH WB WP CAU

LuxSpace Gen4 is the a new LED downlight range combining light comfort and leading performance with luxury appearance

Product data

General Information	
Lamp colour code	840 neutral white
Light source replaceable	No
Number of gear units	1 unit
Driver/power unit/transformer	PSU-E [Power supply unit external (PSU)]
Driver included	Yes
Optic type	Faceted reflector with beam angle 60°
Control interface	DALI
Connection	Plug-in connector 3-pole Wieland/Adels compatible and 2x 2-pole control signal for light regulation
Protection class IEC	Safety class I (I)
Glow-wire test	650/30 [Temperature 650 °C, duration 30 s]
Flammability mark	F [For mounting on normally flammable surfaces]
CE mark	CE mark
Warranty period	3 years
Constant light output	No
Number of products on MCB	24
RoHS mark	RoHS mark

Operating and Electrical	
Input voltage	220 to 240 V
Input frequency	50 or 60 Hz
Inrush current	20.4 A
Inrush time	0.195 ms

Power factor (min.)	0.9
---------------------	-----

Controls and Dimming	
Dimmable	Yes

Mechanical and Housing	
Housing material	Aluminum die-cast
Reflector material	Polycarbonate aluminum coated
Optic material	Polycarbonate
Optical cover/lens material	Polycarbonate
Fixation material	Steel
Optical cover/lens finish	Textured
Overall height	130 mm
Overall diameter	212 mm
Colour	White and black

Approval and Application	
Ingress protection code	IP54/20 [Dust accumulation protected, splash-proof/finger protected]
Mech. impact protection code	IK03 [0.3 J]

Initial Performance (IEC Compliant)	
Initial luminous flux	3400 lm
Luminous flux tolerance	+/-10%
Initial LED luminaire efficacy	105 lm/W

LuxSpace G4

Lamp colour temperature	4000 K
Colour Rendering Index	>80
Initial input power	32.5 W
Power consumption tolerance	+/-10%

Over Time Performance (IEC Compliant)

Median useful life L70B50	50000 h
Median useful life L80B50	50000 h
Median useful life L90B50	21000 h

Application Conditions

Ambient temperature range	-20 to +40 °C
Maximum dimming level	1%

Product Data

Full product code	911401553941
Order product name	DN593B LED30/840 PSD C D200 WH WB WP CAU
Order code	911401553941
Numerator – quantity per pack	1
Numerator – packs per outer box	1
Material no. (12NC)	911401553941
Net weight (piece)	1.399 kg



Dimensional drawing

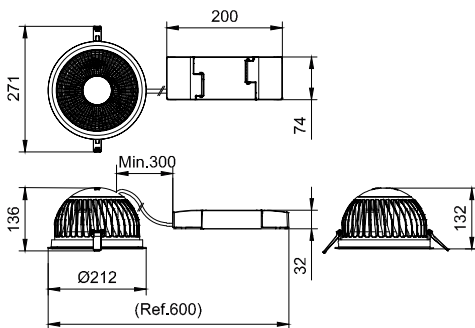

DN58XB/DN59XB

