



GreenSpace G5

DN391B LED11/840 PSD D150 WH CAU

Power supply unit with DALI interface - High-gloss high reflectance - 80°

GreenSpace Gen5 is a new LED downlight range combining light efficiency and comfort with product diversity and system compatibility

Product data

General Information	
Beam angle of light source	85°
Lamp colour code	840 neutral white
Light source replaceable	No
Number of gear units	1 unit
Driver/power unit/transformer	PSD [Power supply unit with DALI interface]
Driver included	Yes
Optic type	C-H [High-gloss high reflectance]
Luminaire light beam spread	80°
Control interface	DALI
Cable	Cord with plug
Protection class IEC	Safety class I (I)
Glow-wire test	650/30 [Temperature 650 °C, duration 30 s]
Flammability mark	F [For mounting on normally flammable surfaces]
Warranty period	3 years
Constant light output	No
Number of products on MCB	24
Operating and Electrical	
Input voltage	220-240 V
Input frequency	50 or 60 Hz

Inrush current	20.4 A
Inrush time	0.195 ms
Power factor (min.)	0.9
Controls and Dimming	
Dimmable	Yes
Mechanical and Housing	
Housing material	Aluminum die-cast
Reflector material	Polycarbonate
Optic material	Polycarbonate
Optical cover/lens material	Polycarbonate
Optical cover/lens finish	Matte
Overall height	100 mm
Overall diameter	162 mm
Colour	Black and White
Approval and Application	
Ingress protection code	IP20 [Finger-protected]
Mech. impact protection code	IK02 [0.2 J standard]

GreenSpace G5

Initial Performance (IEC Compliant)

Initial luminous flux	1100 lm
Luminous flux tolerance	+/-10%
Initial LED luminaire efficacy	96 lm/W
Lamp colour temperature	4000 K
Colour Rendering Index	>80
Initial chromaticity	(0.38,0.38) SDCM<5
Initial input power	11.5 W
Power consumption tolerance	+/-10%

Over Time Performance (IEC Compliant)

Median useful life L70B50	50000 h
Median useful life L80B50	43000 h
Median useful life L90B50	20000 h

Application Conditions

Ambient temperature range	-20 to +40 °C
Suitable for random switching	Not applicable

Product Data

Full product code	911401584341
Order product name	DN391B LED11/840 PSD D150 WH CAU
Order code	911401584341
Numerator – quantity per pack	1
Numerator – packs per outer box	1
Material no. (12NC)	911401584341
Net weight (piece)	0.660 kg

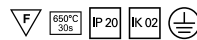

Dimensional drawing

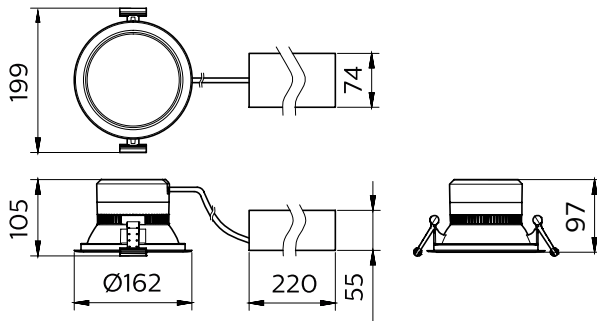

DN391B GreenSpace G5

