



# Essential SmartBright LED Downlight G2

DN027B LED12/CW D150 RD

Power supply unit - Beam angle 110°

Essential SmartBright G2 LED Downlight is value for money product with high efficacy, good quality and reliability. It offers multiple configurations from 300lm to 2000lm output, to replace conventional downlight. It can be used for shopping mall, retail store, residential and office. It's an ideal product family to distribute in trade market.

## Product data

General Information	
Light source replaceable	No
Number of gear units	1 unit
Driver/power unit/transformer	Power supply unit
Driver included	Yes
Optic type	Beam angle 110°
Connection	Flying leads/wires
Protection class IEC	Safety class II
Warranty period	1 years
Constant light output	No
Operating and Electrical	
Input voltage	220-240 V
Input frequency	50 or 60 Hz
Inrush current	15 A
Inrush time	0.158 ms
Power factor (min.)	0.7

Controls and Dimming	
Dimmable	No
Mechanical and Housing	
Housing material	Metal/Plastic
Reflector material	-
Optic material	Polycarbonate
Overall height	33 mm
Overall diameter	175 mm
Approval and Application	
Ingress protection code	IP20 [ Finger-protected]
Mech. impact protection code	IK02 [ 0.2 J standard]
Initial Performance (IEC Compliant)	
Initial luminous flux	1200 lm
Luminous flux tolerance	+/-10%
Lamp colour temperature	6500 K

## Essential SmartBright LED Downlight G2

Colour Rendering Index	80
Initial chromaticity	SDCM<5
Initial input power	15 W
Power consumption tolerance	+/-10%

### Over Time Performance (IEC Compliant)

Median useful life L70B50	20000 h
---------------------------	---------

### Application Conditions

Ambient temperature range	-20 to +40 °C
Suitable for random switching	Not applicable

### Product Data

Full product code	911401812297
Order product name	DN027B LED12/CW D150 RD
EAN/UPC – product	8710163308883
Order code	911401812297
Numerator – quantity per pack	1
Numerator – packs per outer box	24
Material no. (12NC)	911401812297
Net weight (piece)	0.270 kg

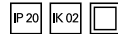

### Dimensional drawing

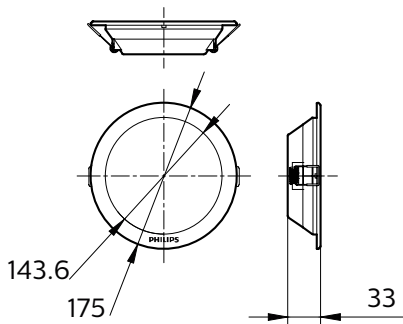

DN027B

