



GreenSpace Surface-mounted

SM295C LED70/840 PSU WH GM

Power supply unit - High-gloss mirror - 60°

Philips GreenSpace Surface-mounted LED Downlight delivers a superior LED alternative that's up to 66% more energy efficient than the conventional downlight retrofits. Blending seamlessly into its environment, GreenSpace Surface-mounted LED Downlight mimics the form of conventional recessed downlights minus the associated high energy and maintenance costs. Philips GreenSpace Surface-mounted LED Downlight is also ideal for all commercial lighting applications as well as public indoor space where there is limited space in the ceiling.

Product data

General Information		Operating and Electrical	
Beam angle of light source	- °	ENEC mark	-
Lamp colour code	840 neutral white	Warranty period	3 years
Light source replaceable	No	Constant light output	No
Number of gear units	1 unit	Number of products on MCB	24
Driver/power unit/transformer	Power supply unit	RoHS mark	-
Driver included	Yes	Input voltage	220 to 240 V
Optic type	High-gloss mirror	Input frequency	50 or 60 Hz
Luminaire light beam spread	60°	Inrush current	25 A
Connection	-	Inrush time	0.202 ms
Cable	-	Power factor (min.)	0.9
Protection class IEC	Safety class I		
Glow-wire test	Temperature 750 °C, duration 5 s		
Flammability mark	-		
CE mark	CE mark		

GreenSpace Surface-mounted

Controls and Dimming

Dimmable	No
----------	----

Mechanical and Housing

Housing material	Aluminium die-cast
Reflector material	Aluminium
Optic material	Aluminium
Optical cover/lens material	-
Fixation material	-
Optical cover/lens finish	-
Overall height	239 mm
Overall diameter	200 mm

Approval and Application

Ingress protection code	IP20 [Finger-protected]
Mech. impact protection code	IK02 [0.2 J standard]

Initial Performance (IEC Compliant)

Initial luminous flux	6600 lm
Luminous flux tolerance	+/-10%
Initial LED luminaire efficacy	100.000 lm/W
Lamp colour temperature	4000 K
Colour Rendering Index	>80
Initial chromaticity	(0.38, 0.38) SDCM <5

Initial input power	66 W
Power consumption tolerance	+/-10%

Over Time Performance (IEC Compliant)

Driver failure rate at 5,000 hours	1.00 %
Median useful life L70B50	50000 h
Median useful life L80B50	40000 h
Median useful life L90B50	20000 h

Application Conditions

Ambient temperature range	-20 to +40 °C
Suitable for random switching	No

Product Data

Full product code	911401848899
Order product name	SM295C LED70/840 PSU WH GM
Order code	911401848899
Numerator – quantity per pack	1
Numerator – packs per outer box	1
Material no. (12NC)	911401848899
Net weight (piece)	2.199 kg

Dimensional drawing

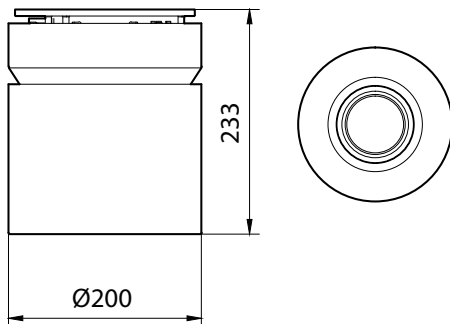

GreenSpace surface-mounted

