



Vaya Linear MP

BCP426 10x50 AM L310 CE

Vaya Linear MP is a reliable and cost-effective LED lighting fixture designed for fixed or dynamic colorful lighting effects. Offering a choice of wide or elliptical beams, Vaya Linear MP is ideal for wall washing and grazing applications. Integrated power and unified power and data connectors make installation fast, easy and reliable.

Product data

General Information	
Lamp family code	LED-HB [LED High Brightness]
Beam angle of light source	10 x 50 °
Light source color	Amber
Light source replaceable	No
Driver included	Yes
Optical cover/lens type	GC [Clear glass]
CE mark	CE mark
UL mark	-
CQC mark	-
Lifetime to 70% luminous flux	60000 h
PSE mark	PSE mark
Operating and Electrical	
Input Voltage	100 to 277 V
Input Frequency	50 to 60 Hz
Controls and Dimming	
Dimmable	No
Mechanical and Housing	
Housing Material	Aluminum extruded
Optic material	Glass

Optical cover/lens material	Tempered glass
Optical cover/lens shape	Flat
Optical cover/lens finish	Clear
Length	310 mm
Approval and Application	
Ingress protection code	IP66 [Dust penetration-protected, jet-proof]
Mech. impact protection code	IK06 [1 J]
Initial Performance (IEC Compliant)	
Init. Corr. Color Temperature	- K
Application Conditions	
Ambient temperature range	-40 to +104 °F
Product Data	
Full product code	871829162636799
Order product name	BCP426 10x50 AM L310 CE
EAN/UPC - Product	8718291626367
Order code	912400130081
Local order code	.
Numerator - Quantity Per Pack	1
Numerator - Packs per outer box	4

Vaya Linear MP

Material Nr. (12NC)	912400130081
Net Weight (Piece)	1.420 kg

IK06

Dimensional drawing

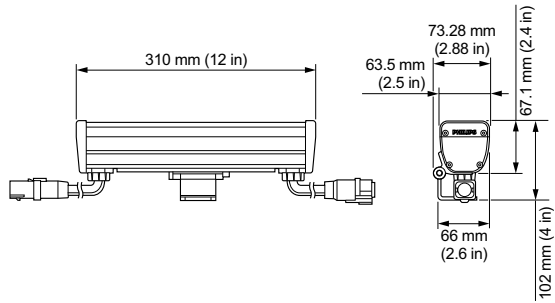

Vaya

