

PHILIPS

Lighting



Vaya Linear MP

BCP425 10x50 2700 L310 CE CQC

Vaya Linear MP is a reliable and cost-effective LED lighting fixture designed for fixed or dynamic colorful lighting effects. Offering a choice of wide or elliptical beams, Vaya Linear MP is ideal for wall washing and grazing applications. Integrated power and unified power and data connectors make installation fast, easy and reliable.

Product data

General Information

Lamp family code	LED-HB [LED High Brightness]
Beam angle of light source	10 x 50 °
Light source color	Warm white
Light source replaceable	No
Driver included	Yes
Optical cover/lens type	GC [Clear glass]
CE mark	CE mark
UL mark	-
CQC mark	CQC-mark
Lifetime to 70% luminous flux	60000 h
PSE mark	No

Operating and Electrical

Input Voltage	100 to 277 V
Input Frequency	50 to 60 Hz

Controls and Dimming

Dimmable	Yes
----------	-----

Mechanical and Housing

Housing Material	Aluminum extruded
Optic material	Glass

Optical cover/lens material	Tempered glass
Optical cover/lens shape	Flat
Optical cover/lens finish	Clear
Length	310 mm

Approval and Application

Ingress protection code	IP66 [Dust penetration-protected, jet-proof]
Mech. impact protection code	IK06 [1 J]

Initial Performance (IEC Compliant)

Initial luminous flux (system flux)	840 lm
Initial luminous flux at color temperature of 2700 K	840 lm
Init. Corr. Color Temperature	2700 K
Initial input power	18 W

Over Time Performance (IEC Compliant)

Lumen Maintenance 70% at 25°C Calculated	100000
Lumen Maintenance 70% at 25°C Reported	60000
Lumen Maintenance 70% at 40°C Calculated	100000
Lumen Maintenance 70% at 40°C Reported	60000
Lumen Maintenance 80% at 25°C Reported	60000
Lumen Maintenance 80% at 40°C Calculated	100000
Lumen Maintenance 80% at 40°C Reported	60000

Vaya Linear MP

Lumen Maintenance 80% at 50°C Calculated	100000
Lumen Maintenance 90% at 25°C Calculated	62000
Lumen Maintenance 90% at 25°C Reported	60000
Lumen Maintenance 90% at 40°C Calculated	62000
Lumen Maintenance 90% at 40°C Reported	60000

Application Conditions

Ambient temperature range	-40 to +104 °F
---------------------------	----------------

Product Data

Full product code	871829162600899
-------------------	-----------------

Order product name	BCP425 10x50 2700 L310 CE CQC
EAN/UPC - Product	8718291626008
Order code	912400130150
Local order code	.
Numerator - Quantity Per Pack	1
Numerator - Packs per outer box	4
Material Nr. (12NC)	912400130150
Net Weight (Piece)	1.420 kg



Dimensional drawing

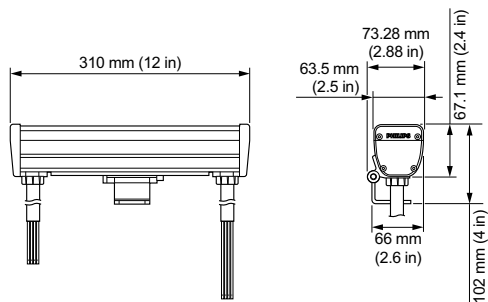

Vaya

