



HF-Regulator II for TL-D lamps

HF-R 236 TL-D EII 220-240V 50/60Hz

High-frequency electronic dimming ballast, using the analog protocol (1-10 V) for TL-D lamps; The ballast is primarily designed for Indoor application. For outdoor application, the luminaire should be minimum Class II need to be sufficiently protected against water & dust. The installation should also be guard against any lightning surge or any other necessary electrical protection as deemed in such typical installation & application.

Product data

General Information	
Application Code	EII
Type Version	mk2
Lamp Type	TL-D
Number of Lamps	2 piece/unit
Number of Products on MCB (16A Type B) (Nom)	12
Automatic Restart	Yes
Operating and Electrical	
Input Voltage	220 to 240 V
Input Frequency	50 to 60 Hz
Operating Frequency (Max)	89 kHz
Operating Frequency (Min)	45 kHz
Ignition Method	Programmed Start
Crestfactor (Max)	1.7
Power Factor 100% Load (Nom)	0.98
Ignition Time (Max)	0.2 s
Mains Voltage Performance (AC)	-8% - +6%

Mains Voltage Safety (AC)	-10% - +10%
Earth Leakage Current (Max)	0.5 mA
Inrush Current Width	0.40 ms
Power Losses (Nom)	7.3 W
Inrush Current Peak (Max)	45 A
Wiring	
Connector Type Input Terminals	WAGO 251 universal connector [Suitable for both automatic wiring (ALF and ADS) and manual wiring]
Connector Type Output Terminals	WAGO 251 universal connector [Suitable for both automatic wiring (ALF and ADS) and manual wiring]
Connector Type Control Input Terminals	WAGO 251 universal connector [Suitable for both automatic wiring (ALF and ADS) and manual wiring]
Wire Striplength	8.0-9.0 mm
Dual Fixture Master/Slave	- [not specified]
Control Input Terminal Cross Section	0.50-1.00 mm ²

HF-Regulator II for TL-D lamps

Input Terminal Cross Section	0.50-1.00 mm ²
Output Terminal Cross Section	0.50-1.00 mm ²
Auto Insert (ALF/ADS) Wire Cross Section	0.5 mm ²
System characteristics	
Rated Ballast-Lamp Power	36 W
Temperature	
T-Ambient (Max)	50 °C
T-Ambient (Min)	10 °C
T-Storage (Max)	80 °C
T-Storage (Min)	-25 °C
Stable Lamp Operation Temperature	Not Specified
T-Ignition (Max)	50 °C
T-Ignition (Min)	0 °C
Controls and Dimming	
Control Interface	1-10V
Regulating Level Power	1%-100%
Control Input Protection	Yes (Basic insulation)
Mechanical and Housing	
Housing	L 360x30x21
Emergency Operation	
Battery Voltage Lamp Ignition	196 V
Battery Voltage Lamp Operation	154-276
Approval and Application	
Energy Efficiency Index	A1 BAT

IP Classification	IP 20 [Ingress Protection 20]
EMI 9 kHz ... 30 MHz	EN55015
EMI 30 MHz ... 1000 MHz	EN55022 level B
Safety Standard	IEC 61347-2-3
Performance Standard	IEC 60929
Quality Standard	ISO 9000:2000
Environmental Standard	ISO 14001
Harmonic Current Emission Standard	IEC 61000-3-2
EMC Immunity Standard	IEC 61547
Vibration Standard	IEC68-2-6 F c
Bumps Standard	IEC 68-2-29 Eb
Humidity Standard	EN 61347-2-3 clause 11
Approval Marks	CE marking ENEC certificate VDE-EMV certificate
Temperature Marking	Yes
Emergency Standard	IEC 60598-2-22
Hum And Noise Level	Inaudible

Product Data

Full product code	871150091015830
Order product name	HF-R 236 TL-D EII 220-240V 50/60Hz
EAN/UPC - Product	8711500910158
Order code	913700609366
Numerator - Quantity Per Pack	1
Numerator - Packs per outer box	12
Material Nr. (12NC)	913700609366
Net Weight (Piece)	0.295 kg

Dimensional drawing

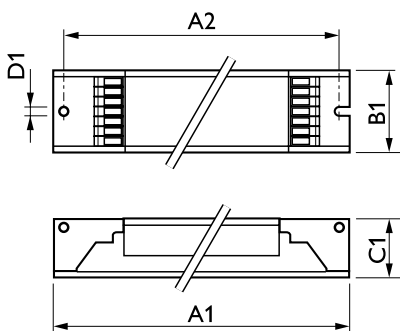

HF-R 236 TL-D EII 220-240V 50/60Hz

Product	D1	C1	A1	A2	B1
HF-R 236 TL-D EII 220-240V 50/60Hz	4.2 mm	22 mm	360 mm	350 mm	30 mm

HF-Regulator II for TL-D lamps

