



Primaline Halogen Transformers

Primaline 105 230-240V 50/60Hz

Philips Primaline is a high-frequency electronic halogen transformer suitable for low-voltage 12 V halogen lamps. It offers ultimate performance and is built with overload and short circuit protection to IEC and ENEC standards. It is available in 70, 105 and 150 W versions and fits in small down light halogen applications.

Product data

General Information	
Type Version	mk2
Lamp Type	LV Halogen
Number of Lamps	2 piece/unit
Operating and Electrical	
Input Voltage	230 to 240 V
Input Frequency	50 to 60 Hz
Input Power (Nom)	50-105 W
System characteristics	
Rated Ballast-Lamp Power	50-105 W
Temperature	
T-Case Lifetime (Nom)	65 °C
T-Case Maximum (Max)	80 °C

Approval and Application	
Approval Marks	SELV CE marking ENEC certificate
Product Data	
Full product code	871150091268830
Order product name	Primaline 105 230-240V 50/60Hz
EAN/UPC - Product	8711500912688
Order code	913700627691
Numerator - Quantity Per Pack	1
Numerator - Packs per outer box	50
Material Nr. (12NC)	913700627691
Net Weight (Piece)	0.126 kg

Warnings and Safety

- Transformer is not suitable for DC operation

Primaline Halogen Transformers

Dimensional drawing

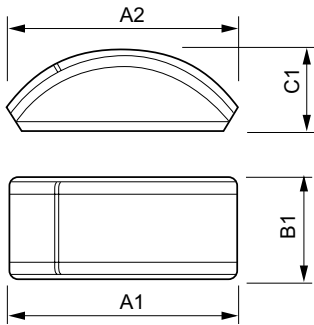

Product	C1	A1	B1
Primaline 105 230-240V 50/60Hz	33 mm	110 mm	45 mm

Primaline 105 230-240V 50/60Hz

