



Dynalite Multipurpose Controllers

DDMC802GL

Multipurpose Modular Controller to control different load types with one device

Multipurpose Modular Controller to control different load types with one device

Product data

General Information	
CE mark	CE mark
Remarks	Please download the Lighting - Product Data Sheet for more information and ordering options
RoHS mark	RoHS mark
Product Family Code	YMPCON [Multipurpose Controllers]
Application Conditions	
Ambient temperature range	0 to +40 °C
Product Data	
Full product code	871016350613500

Order product name	DDMC802GL
EAN/UPC – product	8710163506128
Order code	50613500
Numerator – quantity per pack	1
Numerator – packs per outer box	1
Material no. (12NC)	913703026009
Net weight (piece)	0.600 kg

Dynalite Multipurpose Controllers

Dimensional drawing

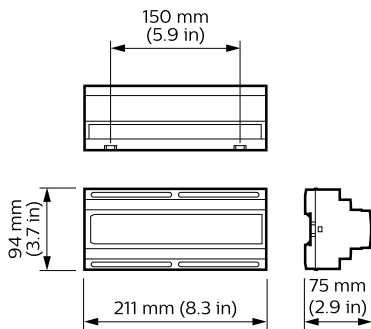

Dynalite Multipurpose Controllers

