



Dynalite Signal Dimmer Controllers

DDBC300-DALI

Signal Dimmer Controller with 3 full universes totalling 192 DALI addresses.

Signal Dimmer Controller with 3 full universes totalling 192 DALI addresses.

Product data

General Information	
CE mark	CE mark
Remarks	Please download the Lighting - Product Data Sheet for more information and ordering options
RoHS mark	RoHS mark
Application Conditions	
Ambient temperature range	0 to +40 °C
Product Data	
Full product code	871016350641800

Order product name	DDBC300-DALI
EAN/UPC – product	8710163506401
Order code	913703031109
Numerator – quantity per pack	1
Numerator – packs per outer box	1
Material no. (12NC)	913703031109
Net weight (piece)	0.410 kg

Dynalite Signal Dimmer Controllers

Dimensional drawing

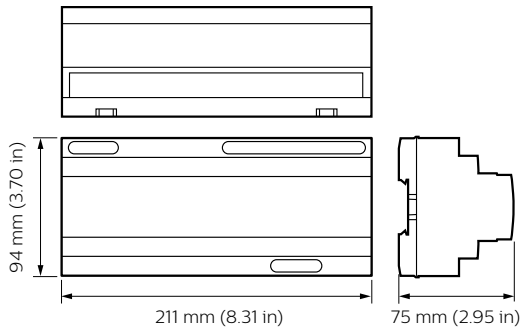

Dynalite Signal Dimmer Controllers

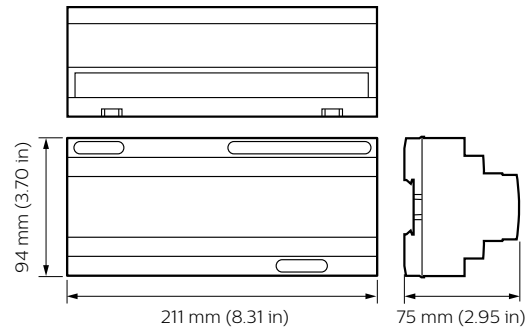

Dynalite Signal Dimmer Controllers

