



Dynalite Sensors

DUS360CR

Low profile 360° ceiling sensor

Low profile 360° ceiling sensor

Product data

General Information	
CE mark	CE mark
Remarks	Please download the Lighting - Product Data Sheet for more information and ordering options
RoHS mark	RoHS mark
Approval and Application	
UL Recognized Canada & US	Yes
Application Conditions	
Ambient temperature range	0 to +45 °C

Product Data	
Full product code	871869688640300
Order product name	DUS360CR
EAN/UPC – product	8718696886403
Order code	88640300
Numerator – quantity per pack	1
Numerator – packs per outer box	1
Material no. (12NC)	913703500709
Net weight (piece)	61.000 g

Dynalite Sensors

Dimensional drawing

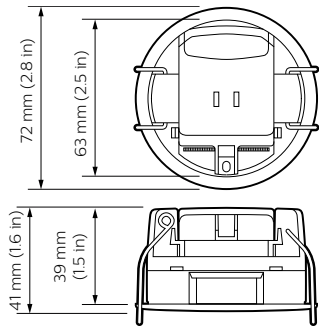

Dynalite Sensors

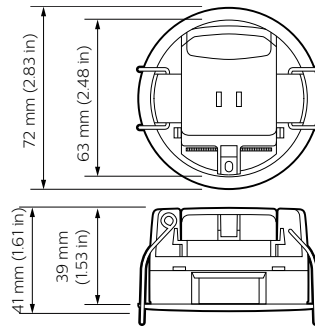

Dynalite Sensors

