



HF-Performer III for TL5 lamps

HF-P 2 14-35 TL5 HE III 220-240V

HF-Performer III TL5 ballasts offer maximum versatility and meet all of the necessary commercial grade specifications. They also offer the added benefits of lamp striation reduction technology, making these ballasts compatible with energy-saving TL5 ECO lamps. As such, these ballasts are part of an overall high-efficiency lighting system that may help you or your customers to achieve any international or local energy code you need to comply with. HF-Performer III TL5 ballasts are the ideal choice for a broad range of new construction and retrofit applications within the commercial sector, including general surface mounting or office lighting, parking garages, warehouses, waterproof and other applications.

Product data

General Information		Electrical	
Application Code	III	Ignition Time (Max)	0.9 s
Type Version	IDC	Mains Voltage Performance (AC)	-8% - +6%
Lamp Type	TL5 HE	Mains Voltage Safety (AC)	-10% - +10%
Number of Lamps	2 piece/unit	Earth Leakage Current (Nom)	0.5 mA
Number of Products on MCB (16A Type B) (Nom)	28	Inrush Current Width	0.25 ms
Automatic Restart	Yes	Constant Wattage Deviation	-2% / +2%
		Ballast Factor (Nom)	1
		Power Losses (Nom)	2-5.5 W
		Inrush Current Peak (Max)	24 A
Operating and Electrical		Wiring	
Input Voltage	220 to 240 V	Connector Type Input Terminals	WAGO 251 universal connector [Suitable for both automatic wiring (ALF and ADS) and manual wiring]
Input Frequency	50 to 60 Hz	Cable Capacity Output Wires Mutual (Nom)	200 pF
Operating Frequency (Nom)	45 kHz		
Ignition Method	Programmed Start		
Crestfactor (Max)	1.7		
Power Factor 100% Load (Nom)	0.99		

HF-Performer III for TL5 lamps

Connector Type Output Terminals	WAGO 251 universal connector [Suitable for both automatic wiring (ALF and ADS) and manual wiring]
Cable Length Hot Wiring	0.75 m
Wire Striplength	8.0-9.0 mm
Dual Fixture Master/Slave	Not applicable [Master/Slave oper. not applicable]
Input Terminal Cross Section	0.50-1.00 mm ²
Output Terminal Cross Section	0.50-1.00 mm ²
Cable Capacity Output Wires to Earth (Nom)	200 pF

System characteristics

Rated Ballast-Lamp Power	14-35 W
Rated Lamp Power on TL5 HE	14/35 W
System Power on TL5 HE	36.8/75.6 W
Lamp Power on TL5 HE	28.0/70.0 W
Power Loss on TL5 HE	2.8/5.6 W

Temperature

T-Ambient (Max)	60 °C
T-Ambient (Min)	-25 °C
T-Storage (Max)	80 °C
T-Storage (Min)	-40 °C
T-Case Lifetime (Nom)	80 °C
T-Case Maximum (Max)	80 °C
T-Ignition (Max)	60 °C
T-Ignition (Min)	-25 °C

Mechanical and Housing

Housing	L360x30x22
---------	------------

Emergency Operation

Nominal Light Output After 60 Seconds	100% of EBLF
Battery Voltage Lamp Ignition	176-276 V
Normal Operating Voltage (DC)	220-240 V
Battery Voltage Lamp Operation	176-276
Battery Voltage Guaranteed Operation	176-275 V

Battery Voltage Guaranteed Ignition	186-275 V
Emergency Ballast Lumen Factor (EBLF) (Nom)	100 %
Nominal Light Output After 5 Seconds	50% of EBLF

Approval and Application

Energy Efficiency Index	A2 BAT
IP Classification	IP 20 [Ingress Protection 20]
EMI 9 kHz ... 30 MHz	EN55015
EMI 30 MHz ... 1000 MHz	-
Safety Standard	IEC 61347-2-3
Performance Standard	IEC 60929
Quality Standard	ISO 9000:2000
Environmental Standard	ISO 14001
Harmonic Current Emission Standard	IEC 61000-3-2
EMC Immunity Standard	IEC 61547
Vibration Standard	IEC68-2-6 F c
Bumps Standard	IEC 68-2-29 Eb
Humidity Standard	EN 61347-2-3 clause 11
Approval Marks	CE marking ENEC certificate VDE-EMV certificate
Temperature Marking	Yes
Emergency Standard	IEC 60598-2-22
Hum And Noise Level	< 30 dB(A)

Product Data

Full product code	872790090503800
Order product name	HF-P 2 14-35 TL5 HE III 220-240V
EAN/UPC - Product	8711500999238
Order code	90503800
Numerator - Quantity Per Pack	1
Numerator - Packs per outer box	12
Material Nr. (12NC)	913713031166
Net Weight (Piece)	0.245 kg

Dimensional drawing

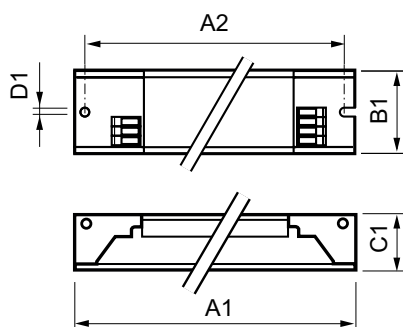

HF-P 2 14-35 TL5 HE III 220-240V

Product	D1	C1	A1	A2	B1
HF-P 2 14-35 TL5 HE III 220-240V	4.2 mm	22.0 mm	360.0 mm	350.0 mm	30.0 mm

HF-Performer III for TL5 lamps

