



MASTER LEDspot LV AR111

MAS LEDspotLV D 15-75W 927 AR111 24D

Delivering a warm, halogen-like accent beam, MASTER LEDspot LV AR111 is an ideal retrofit solution for spot and general lighting applications in the hospitality and retail industry. It is particularly suitable for general lighting where the light is on all the time, such as creative accent lighting applications in shops, restaurants, hotels, and especially for galleries, exhibitions and museums. The robustly designed MASTER LEDspot LV AR111 offers various beam angles for a clearly defined beam spread. There is no UV or IR in the beam, making it suitable for illuminating heat-sensitive objects (food, organic materials, paintings, etc.). The patented intelligent driver enables broad compatibility with existing electromagnetic and electronic halogen transformers. MASTER LEDspot LV AR111 delivers huge energy savings and minimizes maintenance cost without any reduction in brightness.

Product data

General Information		Operating and Electrical	
Cap-Base	G53 [G53]	Rated Beam Angle	24 °
Nominal Lifetime (Nom)	40000 h	Correlated Color Temperature (Nom)	2700 K
Switching Cycle	50000X	Luminous Efficacy (rated) (Nom)	55.33 lm/W
Technical Type	15-75W	Color Consistency	<6
		Color Rendering Index (Nom)	90
		LLMF At End Of Nominal Lifetime (Nom)	70 %
		Luminous Flux in 90° Cone (Rated)	760 lm
Light Technical			
Color Code	927	Power (Rated) (Nom)	15 W
Beam Angle (Nom)	24 °	Lamp Current (Nom)	1800 mA
Light Distribution	24D [Medium beam]	Wattage Equivalent	75 W
Luminous Flux (Nom)	830 lm	Starting Time (Nom)	0.5 s
Luminous Flux (Rated) (Nom)	830 lm	Warm Up Time to 60% Light (Nom)	instant full light
Luminous Intensity (Nom)	3900 cd		
Color Designation	Warm White (WW)		

MASTER LEDspot LV AR111

Power Factor (Nom)	0.7
Voltage (Nom)	12 V
Temperature	
T-Case Maximum (Nom)	74 °C
Controls and Dimming	
Dimmable	Yes
Approval and Application	
Energy Efficiency Label (EEL)	A
Suitable For Accent Lighting	Yes
Energy Consumption kWh/1000 h	16 kWh

Product Data	
Full product code	871869651516700
Order product name	MAS LEDspotLV D 15-75W 927 AR111 24D
EAN/UPC - Product	8718696515167
Order code	929001170208
Numerator - Quantity Per Pack	1
Numerator - Packs per outer box	6
Material Nr. (12NC)	929001170208
Net Weight (Piece)	0.360 kg

Dimensional drawing

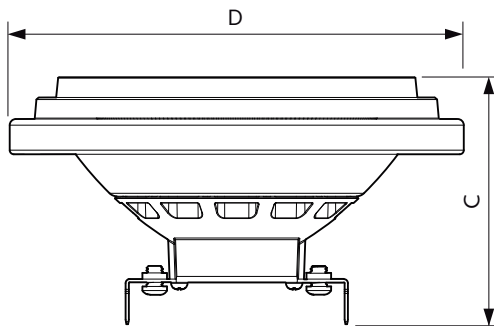

LED D 15-75W 927 AR111 24D

Product	D	C
MAS LEDspotLV D 15-75W 927 AR111 24D	111 mm	62 mm

Photometric data

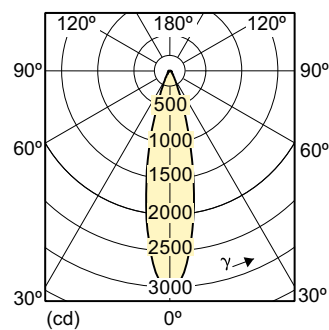
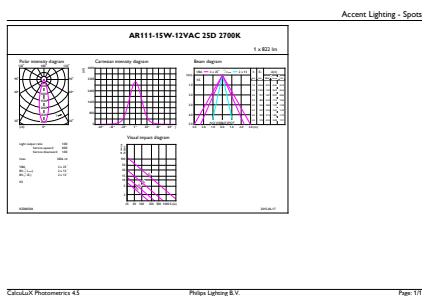

MASTER LEDspot LV AR111 75W G53 927 24D

15-75 W GX53 /927 AR111 24D

MASTER LEDspot LV AR111

Photometric data

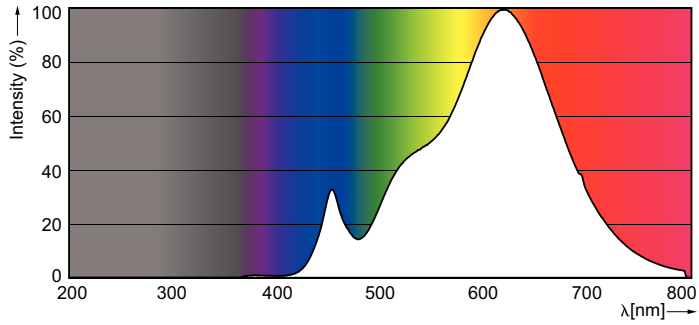

15-75W AR111 /927

Lifetime

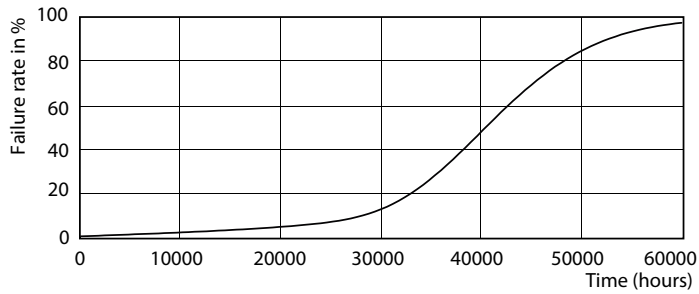

MASTER LEDspotLV AR111 75W G53 940 40D

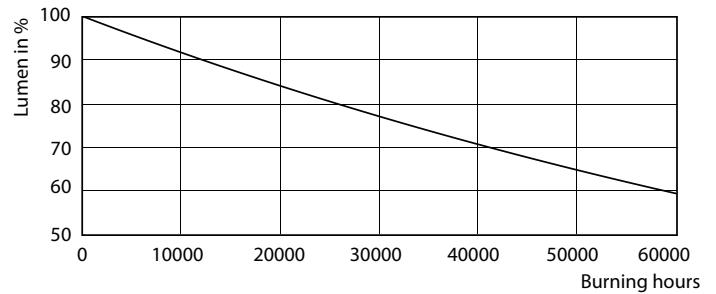

MASTER LEDspotLV AR111 75W G53 940 40D

