



MASTER LEDspot LV AR111

MAS LEDspotLV D 15-75W 930 AR111 40D

Delivering a warm, halogen-like accent beam, MASTER LEDspot LV AR111 is an ideal retrofit solution for spot and general lighting applications in the hospitality and retail industry. It is particularly suitable for general lighting where the light is on all the time, such as creative accent lighting applications in shops, restaurants, hotels, and especially for galleries, exhibitions and museums. The robustly designed MASTER LEDspot LV AR111 offers various beam angles for a clearly defined beam spread. There is no UV or IR in the beam, making it suitable for illuminating heat-sensitive objects (food, organic materials, paintings, etc.). The patented intelligent driver enables broad compatibility with existing electromagnetic and electronic halogen transformers. MASTER LEDspot LV AR111 delivers huge energy savings and minimizes maintenance cost without any reduction in brightness.

Product data

General Information	
Cap-Base	G53 [G53]
Nominal Lifetime (Nom)	40000 h
Switching Cycle	50000X
Technical Type	15-75W
Light Technical	
Colour Code	930 [CCT of 3000K]
Beam Angle (Nom)	40 °
Light Distribution	40D [Medium beam]
Luminous Flux (Nom)	810 lm
Luminous Flux (Rated) (Nom)	810 lm
Luminous Intensity (Nom)	1450 cd
Colour Designation	White (WH)

Rated Beam Angle	40 °
Colour Temperature, horizontal (Nom)	3000 K
Luminous Efficacy (rated) (Nom)	54.00 lm/W
Color Consistency	<3
Colour Rendering Index horiz (Nom)	90
LLMF At End Of Nominal Lifetime (Nom)	70 %
Luminous Flux in 90° Cone (Rated)	810 lm
Operating and Electrical	
Power (Rated) (Nom)	15 W
Lamp Current (Nom)	1800 mA
Wattage Equivalent	75 W
Starting Time (Nom)	0.5 s
Warm Up Time to 60% Light (Nom)	0.5 s

MASTER LEDspot LV AR111

Power Factor (Nom)	0.7
Voltage (Nom)	12 V
Temperature	
T-Case Maximum (Nom)	74 °C
Controls and Dimming	
Dimmable	Yes
Approval and Application	
Energy Efficiency Label	A
Suitable For Accent Lighting	Yes
Energy Consumption kWh/1000 h	17 kWh

Product Data	
Full product code	871869651502000
Order product name	MAS LEDspotLV D 15-75W 930 AR111 40D
EAN/UPC - Product	8718696515020
Order code	51502000
Numerator - Quantity Per Pack	1
Numerator - Packs per outer box	6
Material Nr. (12NC)	929001170502
Net Weight (Piece)	0.160 kg

Dimensional drawing

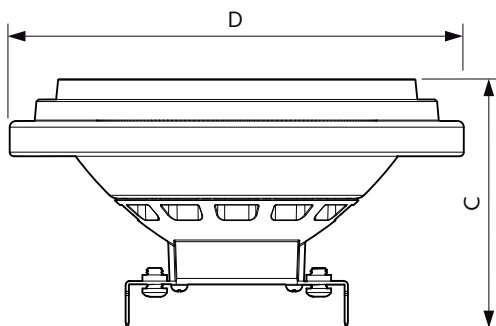

LED D 15-75W 930 AR111 40D

Product	D	C
MAS LEDspotLV D 15-75W 930 AR111 40D	111 mm	62 mm

Photometric data

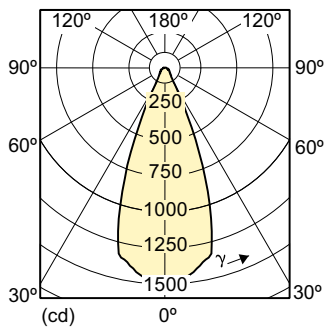
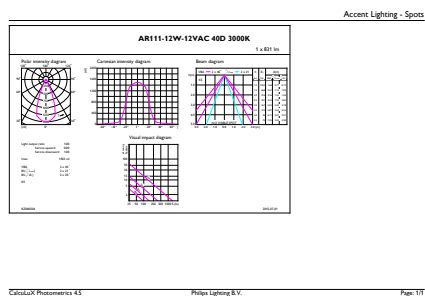

MASTER LEDspot LV AR111 75W G53 930 40D

15-75 W GX53 /930 AR111 40D

MASTER LEDspot LV AR111

Photometric data

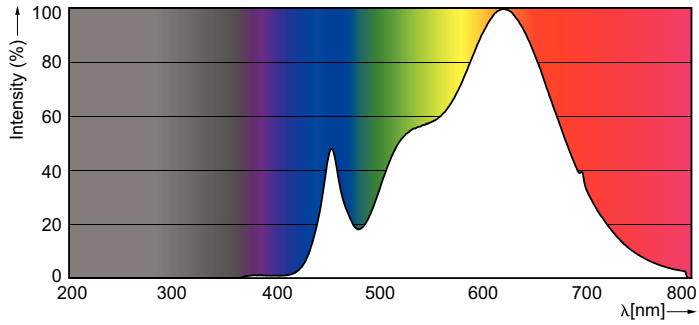

15-75W AR111 /930

Lifetime

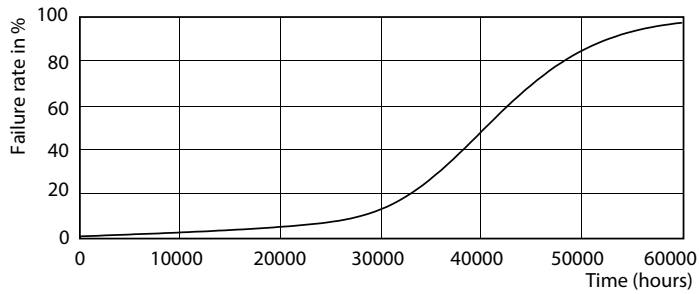

MASTER LEDspotLV AR111 75W G53 940 40D

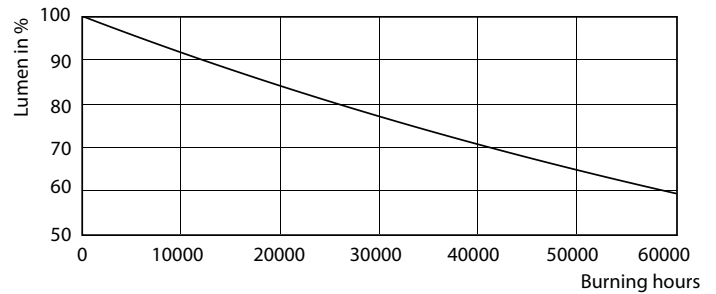

MASTER LEDspotLV AR111 75W G53 940 40D

