



# MASTER LEDspot LV AR111

## MAS LEDspotLV D 15-75W 930 AR111 40D

With its new perfect-fit design, the Master LEDspot LV AR111 now works with most of G53 luminaires as a true retrofit solution. The lamp creates a brilliant visual effect for retail and hospitality applications such as shops, showrooms and galleries. The high quality light brings out the true colors in merchandise and emphasizes its beauty. It also lasts long, with a strong lumen and color maintenance. The beautifully designed lamp offers a well-defined beam with a multitude of beam angles to suit various applications. Not only does it employ the Philips patented solution to ensure it is compatible with a broad selection of standard 12V halogen electronic transformers, it also delivers high beam intensity which equivalent to halogen AR111 spots of 50W, 75W or 100W.

### Product data

General Information	
Cap-Base	G53 [G53]
Nominal lifetime	40,000 hour(s)
Switching Cycle	50,000
Lighting Technology	LED
EU RoHS compliant	Yes
Light Technical	
Color Code	930 [CCT of 3000K]
Beam Angle (Nom)	40 degree(s)
Luminous Flux	840 lm
Luminous Intensity (Nom)	1,450 cd
Color Designation	White (WH)
Correlated Color Temperature (Nom)	3000 K
Luminous Efficacy (rated) (Nom)	56.00 lm/W

Color Consistency	<6
Color rendering index (CRI)	90
LLMF At End Of Nominal Lifetime (Nom)	70 %
Luminous Flux in 90° Cone (Rated)	760 lm
Operating and Electrical	
Line Frequency	- Hz
Input Frequency	- Hz
Power Consumption	15 W
Lamp Current (Nom)	1,800 mA
Wattage Equivalent	75 W
Starting Time (Nom)	0.5 s
Warm-up time to 60% light	instant full light s
Power Factor (Fraction)	0.7

# MASTER LEDspot LV AR111

Voltage (Nom)	12 V
<b>Temperature</b>	
T-Case Maximum (Nom)	74 °C
<b>Controls and Dimming</b>	
Dimmable	Yes
<b>Mechanical and Housing</b>	
Bulb Shape	AR111
<b>Approval and Application</b>	
Suitable For Accent Lighting	Yes
Energy Consumption kWh/1000 h	17 kWh

<b>Product Data</b>	
Order product name	MAS LEDspotLV D 15-75W 930 AR111 40D
Full product name	MAS LEDspotLV D 15-75W 930 AR111 40D
Full product code	871869651522800
Order code	929001170508
Material Nr. (12NC)	929001170508
Numerator - Quantity Per Pack	1
EAN/UPC - Product/Case	8718696515228
Numerator - Packs per outer box	6
EAN/UPC - Case	8718696515235

## Dimensional drawing

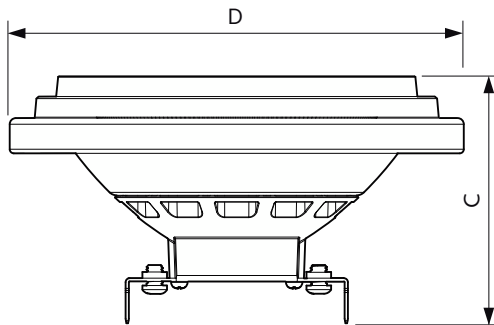

Product	D	C
MAS LEDspotLV D 15-75W 930 AR111 40D	111 mm	62 mm

## Photometric data

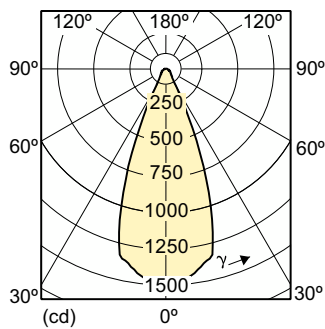
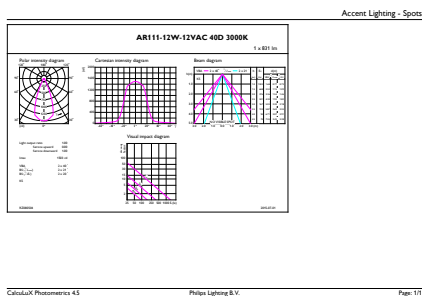

Accent Lighting Spots - MAS LEDspotLV D 15-75W 930 AR111 40D

Light Distribution Diagram - MAS LEDspotLV D 15-75W 930 AR111 40D

# MASTER LEDspot LV AR111

## Photometric data



Spectral Power Distribution Colour - MAS LEDspotLV D 15-75W 930 AR111 40D

## Lifetime

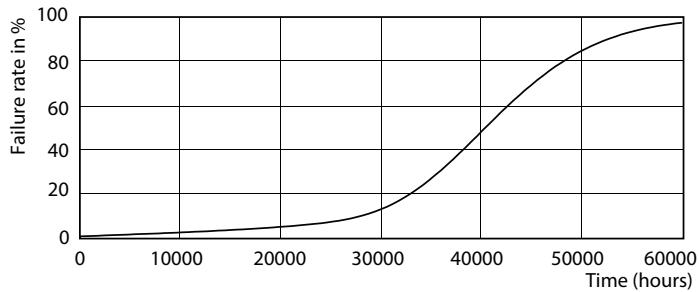

Life Expectancy Diagram - MAS LEDspotLV D 15-75W 930 AR111 40D

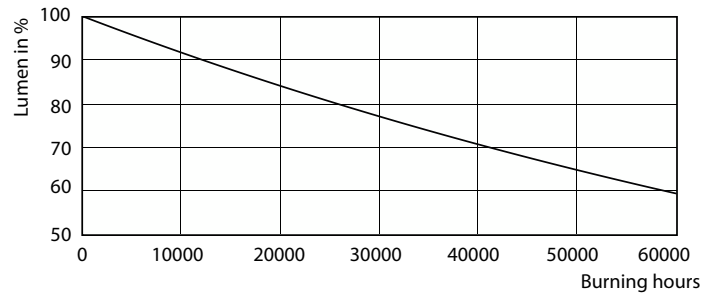

Lumen Maintenance Diagram - MAS LEDspotLV D 15-75W 930 AR111 40D

