



MASTER LEDbulb

MAS LEDbulb DT 11-75W A67 B22 827 FR

MASTER LEDbulb range delivers a dimmable glow effect for a welcoming, warm atmosphere, making it ideal for general lighting applications in the hospitality industry. Its unique design radiates warm light in all directions, making it a true alternative to the incandescent lamp. It is particularly suitable for public areas such as lobbies, corridors, stairwells, where the light is always on. Compatible with existing fixtures with an E27 or a B22 holder and designed for retrofit replacement of incandescent bulbs, MASTER LEDbulb delivers huge energy savings and minimises maintenance cost without any compromise on light quality.

Product data

General Information	
Cap base	B22 [B22]
Main application	Industrial
Nominal lifetime (nom.)	25000 h
Switching cycle	50000X
Light Technical	
Colour Code	822-827 [tunable warm white]
Lamp Luminous Flux 25°C EL (Nom)	1055 lm
Lamp Luminous Flux (Nom)	1055 lm
Colour Designation	Warm white (WW)
Colour Temperature, horizontal (Nom)	2200-2700 K
Lamp Luminous Efficacy EM (Nom)	96 lm/W
Colour consistency	<6
Colour Rendering Index, horiz (Nom)	80
LLMF at end of nominal lifetime (nom.)	70 %
Operating and Electrical	
Input frequency	50 to 60 Hz

Power (Rated) (Nom)	11 W
Lamp current (nom.)	63 mA
Wattage equivalent	75 W
Starting time (nom.)	0.5 s
Warm-up time to 60% light (nom.)	0.5 s
Power factor (nom.)	0.7
Voltage (Nom)	220-240 V
Temperature	
T-Case maximum (nom.)	100 °C
Controls and Dimming	
Dimmable	Yes
Approval and Application	
Energy efficiency label (EEL)	A+
Energy-saving product	Yes
Suitable for accent lighting	No

MASTER LEDbulb

Energy Consumption kWh/1000 h	11 kWh
Product Data	
Full product code	87186965553800
Order product name	MAS LEDbulb DT 11-75W A67 B22 827 FR
EAN/UPC – product	8718696555538
Order code	55553800

Numerator – quantity per pack	1
Numerator – packs per outer box	6
Material no. (12NC)	929001200402
Net weight (piece)	0.131 kg

Warnings and Safety

- Operating temperature range is between -20° C and 45° C ambient
- Only to apply in dry or damp locations and most of open fixtures with lamp-holders that offer sufficient space (10 mm free air space)
- Not intended for use with emergency light fixtures or exit lights

Dimensional drawing

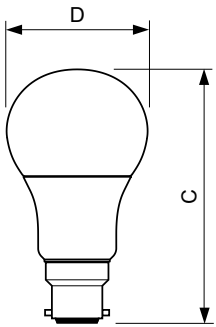

Bulb230V 13W-75W 1055lm 300D 2700K B22 D

Product	D	C
MAS LEDbulb DT 11-75W A67 B22 827 FR	70.6 mm	135.9 mm

Photometric data

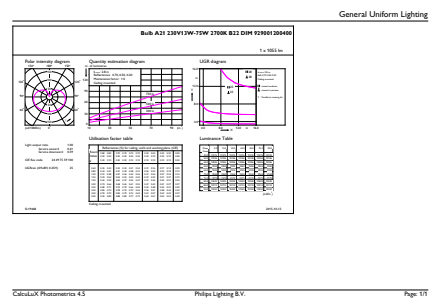
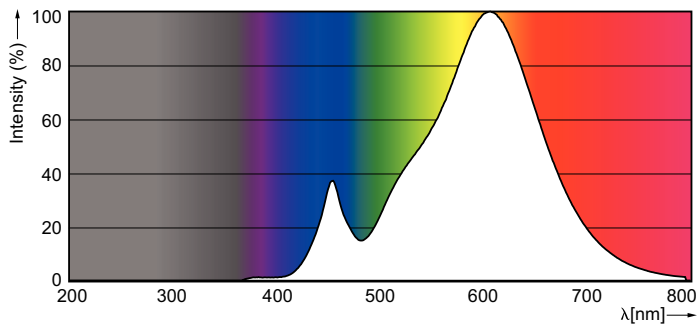

LEDbulb 75W A67 2700K

MASTER LEDbulb

Photometric data

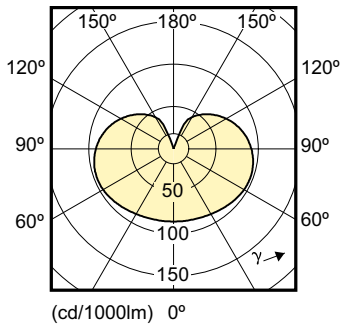

LEDbulb 75W, 100W A67 2700K

