



CorePro LED PLC

CorePro LED PLC 9W 840 4P G24q-3

Philips CorePro LED PLC is the ideal uplamping solution for downlights in a wide range of general lighting applications. It integrates a LED light source into a traditional fluorescent form factor to offer superb energy savings over a lifetime that's twice as long as fluorescent alternatives.

Product data

General Information		Voltage (Nom)	
Cap base	G24Q-3 [G24q-3]	20-50 V	
Nominal lifetime (nom.)	30000 h	Temperature	
Switching cycle	50000X	T ambient (max.)	35 °C
B50L70	30000 h	T ambient (min.)	-20 °C
		T storage (max.)	65 °C
		T storage (min.)	-40 °C
		T-Case maximum (nom.)	76 °C
Light Technical		Controls and Dimming	
Colour Code	840 [CCT of 4,000 K]	Dimmable	no
Lamp Luminous Flux 25°C EL (Nom)	1000 lm	Mechanical and Housing	
Lamp Luminous Flux (Nom)	1000 lm	Product length	200 mm
Colour Temperature, horizontal (Nom)	4000 K	Approval and Application	
Colour consistency	<6	Energy efficiency label (EEL)	A+
Colour Rendering Index,horiz (Nom)	83	Energy-saving product	Yes
LLMF at end of nominal lifetime (nom.)	70 %	Approval marks	CE marking RoHS compliance KEMA Keur certificate
Operating and Electrical		Energy Consumption kWh/1000 h	12 kWh
Input frequency	30000-80000 Hz		
Power (Rated) (Nom)	9 W		
Lamp current (max.)	400 mA		
Lamp current (min.)	250 mA		
Starting time (nom.)	0.5 s		
Warm-up time to 60% light (nom.)	0.5 s		
Power factor (nom.)	0.9		

CorePro LED PLC

Product Data

Full product code	871869654117300
Order product name	CorePro LED PLC 9W 840 4P G24q-3
EAN/UPC – product	8718696541173
Order code	929001200902
Numerator – quantity per pack	1

Numerator – packs per outer box	10
Material no. (12NC)	929001200902
Net weight (piece)	0.088 kg

Dimensional drawing

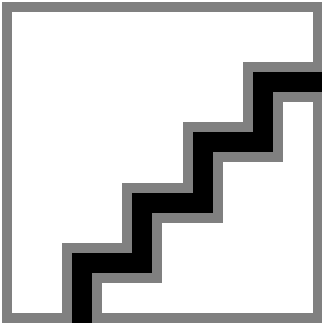

LEDtube PLC 9W G24q-3/840 4P

Product	D1	D2	A1	A2	A3
CorePro LED PLC 9W 840 4P G24q-3	24.3 mm	28.4 mm	128.8 mm	148 mm	163.6 mm

Photometric data

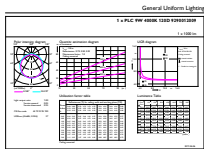

LEDtube PLC 100mm 9W G24Q-3 840 1000lm

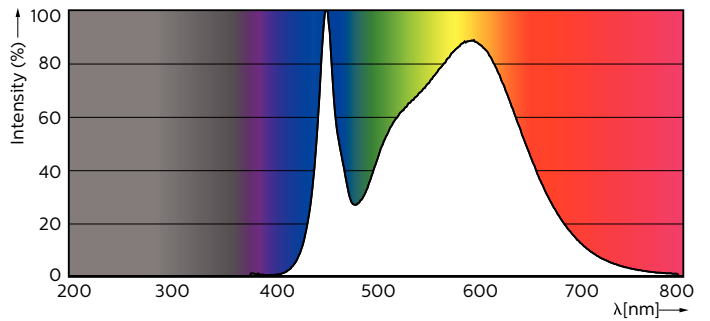

LEDtube PLC 100mm 9W G24Q-3 840 1000lm

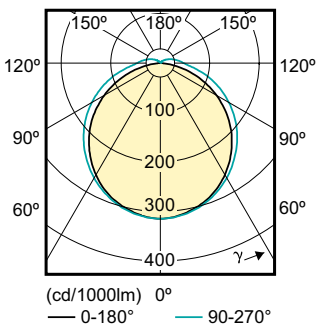

CorePro LED PLC

Lifetime



LEDtube PLC 100mm 9W G24Q-3 830 950lm



LEDtube PLC 100mm 9W G24Q-3 830 950lm

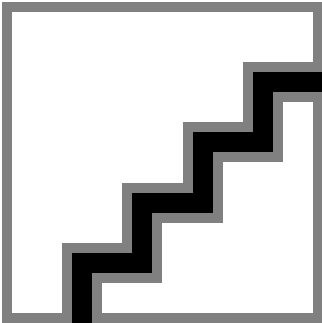

LEDtube PLC 100mm 9W G24Q-3 830 950lm

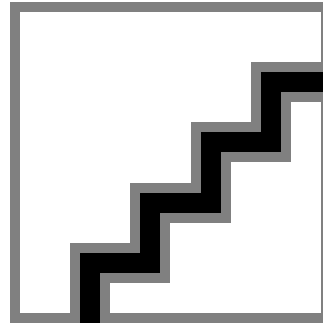

LEDtube PLC 100mm 9W G24Q-3 830 950lm

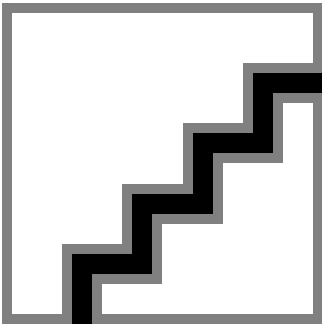

LEDtube PLC 100mm 9W G24Q-3 830 950lm

CorePro LED PLC

