



# CorePro LED PLC

## CorePro LED PLC CorePro LED PLC 8.5W 840 2P G24d-3

Philips CorePro LED PLC is the ideal uplamping solution for downlights in a wide range of general lighting applications. It integrates a LED light source into a traditional fluorescent form factor to offer superb energy savings over a lifetime that's twice as long as fluorescent alternatives.

### Product data

General Information		Power Factor (Nom)	
Cap-Base	G24D-3 [ G24d-3]		0.9
Nominal Lifetime (Nom)	30000 h	Voltage (Nom)	220-240 V
Switching Cycle	50000X	<b>Temperature</b>	
B50L70	30000 h	T-Ambient (Max)	35 °C
<b>Light Technical</b>		T-Ambient (Min)	-20 °C
Color Code	840 [ CCT of 4000K]	T-Storage (Max)	65 °C
Luminous Flux (Nom)	1000 lm	T-Storage (Min)	-40 °C
Luminous Flux (Rated) (Nom)	1000 lm	T-Case Maximum (Nom)	75 °C
Correlated Color Temperature (Nom)	4000 K	<b>Controls and Dimming</b>	
Color Consistency	<6	Dimmable	No
Color Rendering Index (Nom)	83	<b>Mechanical and Housing</b>	
LLMF At End Of Nominal Lifetime (Nom)	70 %	Product Length	200 mm
<b>Operating and Electrical</b>		<b>Approval and Application</b>	
Input Frequency	50 to 60 Hz	Energy Efficiency Label (EEL)	A+
Power (Rated) (Nom)	8.5 W	Energy Saving Product	Yes
Lamp Current (Max)	43 mA	Approval Marks	TUV CE marking RoHS compliance KEMA Keur certificate
Lamp Current (Min)	33 mA		
Starting Time (Nom)	0.5 s		
Warm Up Time to 60% Light (Nom)	0.5 s		

# CorePro LED PLC

Energy Consumption kWh/1000 h	11 kWh
<b>Product Data</b>	
Full product code	871869654125800
Order product name	CorePro LED PLC CorePro LED PLC 8.5W 840 2P G24d-3
EAN/UPC - Product	8718696541258

Order code	929001201302
Numerator - Quantity Per Pack	1
Numerator - Packs per outer box	10
Material Nr. (12NC)	929001201302
Net Weight (Piece)	0.090 kg

## Warnings and Safety

- NOTES: The overall energy efficiency and light distribution of any installation that uses these lamps are determined by the design of the installation.

## Dimensional drawing

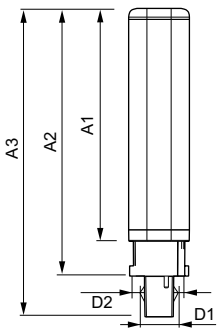

LEDtube PLC 8.5W G24d-3/840 2P

Product	D1	D2	A1	A2	A3
CorePro LED PLC CorePro LED PLC 8.5W 840 2P G24d-3	24.3 mm	28.4 mm	128.8 mm	148 mm	170.6 mm

## Photometric data

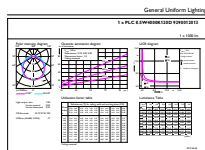

General Information 11 Photo Lighting 11 Page 117

LEDtube PLC 100mm 9W G24D-3 840 1000lm

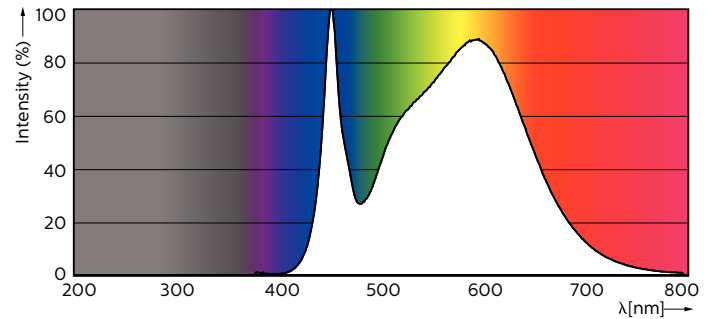

LEDtube PLC 100mm 9W G24Q-3 840 1000lm

# CorePro LED PLC

## Photometric data

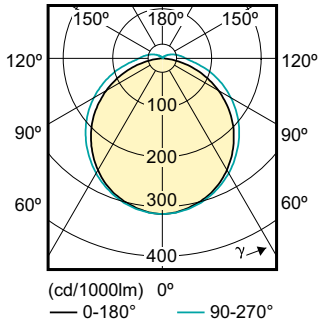

PLC /830, /840

## Lifetime

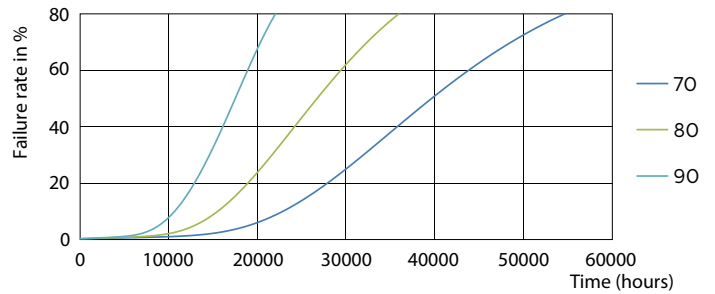
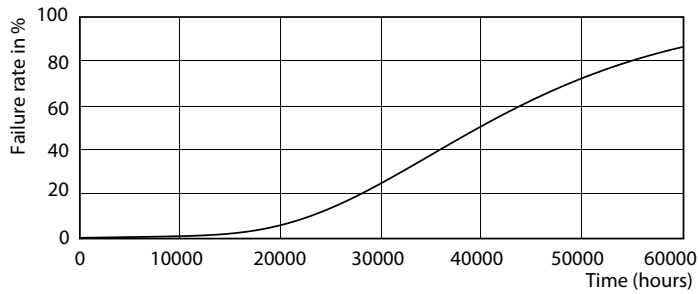

LEDtube PLC 100mm 9W G24D-3 830 950lm

LEDtube PLC 100mm 9W G24D-3 830 950lm

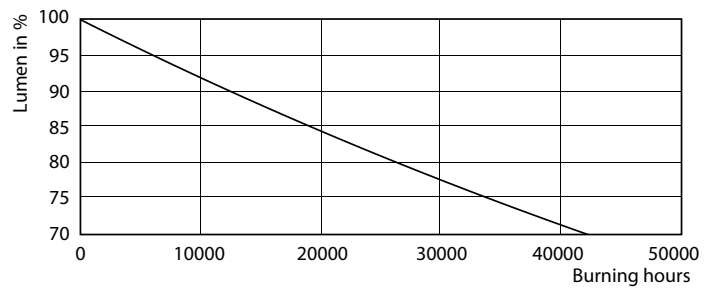
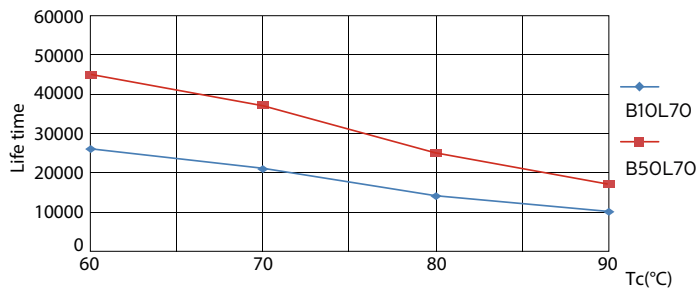

LEDtube PLC 100mm 9W G24D-3 830 950lm

LEDtube PLC 100mm 9W G24D-3 830 950lm

# CorePro LED PLC

## Lifetime

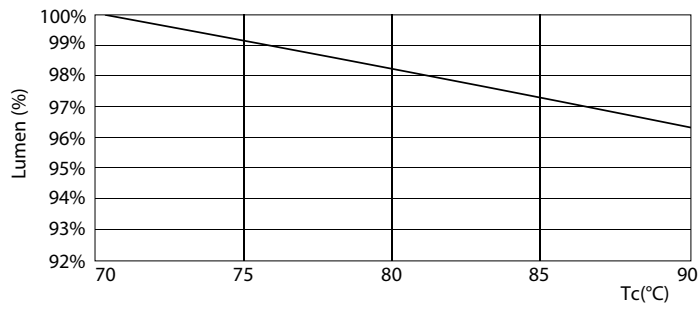

LEDtube PLC 100mm 9W G24D-3 830 950lm

