



CorePro LED PLC

CorePro LED PLC LED PLC 8.5W 840 2P G24d-3

Philips CorePro LED PLC is the ideal uplamping solution for downlights in a wide range of general lighting applications. It integrates a LED light source into a traditional fluorescent form factor to offer superb energy savings over a lifetime that's twice as long as fluorescent alternatives.

Product data

General Information	
Cap base	G24D-3 [G24d-3]
Nominal lifetime (nom.)	30000 h
Switching cycle	50000X
B50L70	30000 h
Light Technical	
Colour Code	840 [CCT of 4,000 K]
Lamp Luminous Flux 25°C EL (Nom)	1000 lm
Lamp Luminous Flux (Nom)	1000 lm
Colour Temperature, horizontal (Nom)	4000 K
Colour consistency	<6
Colour Rendering Index,horiz (Nom)	83
LLMF at end of nominal lifetime (nom.)	70 %
Operating and Electrical	
Input frequency	50 to 60 Hz
Power (Rated) (Nom)	8.5 W
Lamp current (max.)	43 mA
Lamp current (min.)	33 mA
Starting time (nom.)	0.5 s
Warm-up time to 60% light (nom.)	0.5 s
Power factor (nom.)	0.9

Voltage (Nom)	220-240 V
Temperature	
T ambient (max.)	35 °C
T ambient (min.)	-20 °C
T storage (max.)	65 °C
T storage (min.)	-40 °C
T-Case maximum (nom.)	75 °C
Controls and Dimming	
Dimmable	no
Mechanical and Housing	
Product length	200 mm
Approval and Application	
Energy efficiency label (EEL)	A+
Energy-saving product	Yes
Approval marks	CE marking RoHS compliance KEMA Keur certificate
Energy Consumption kWh/1000 h	11 kWh

CorePro LED PLC

Product Data

Full product code	871869667001900
Order product name	CorePro LED PLC LED PLC 8.5W 840 2P G24d-3
EAN/UPC – product	8718696670019
Order code	929001201308
Numerator – quantity per pack	1

Numerator – packs per outer box	10
Material no. (12NC)	929001201308
Net weight (piece)	0.090 kg

Dimensional drawing

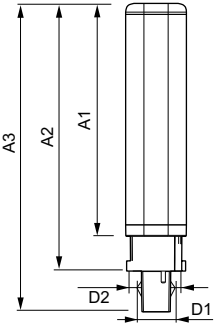

LEDtube PLC 8.5W G24d-3/840 2P

Product	D1	D2	A1	A2	A3
CorePro LED PLC LED PLC 8.5W 840 2P G24d-3	24.3 mm	28.4 mm	128.8 mm	148 mm	170.6 mm

Photometric data

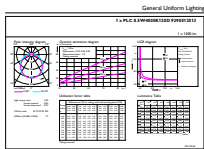

General Information 11 Photo Lighting 11 Page 117

LEDtube PLC 100mm 9W G24D-3 840 1000lm

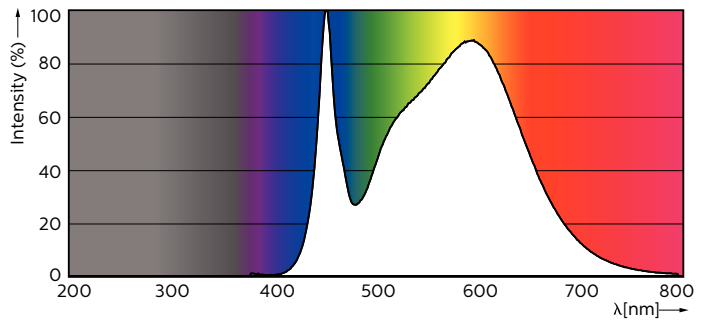

LEDtube PLC 100mm 9W G24Q-3 840 1000lm

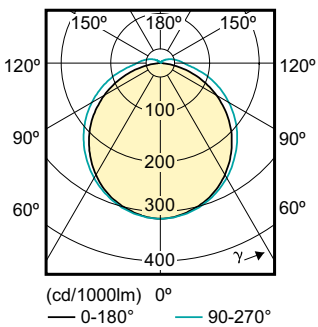

CorePro LED PLC

Lifetime

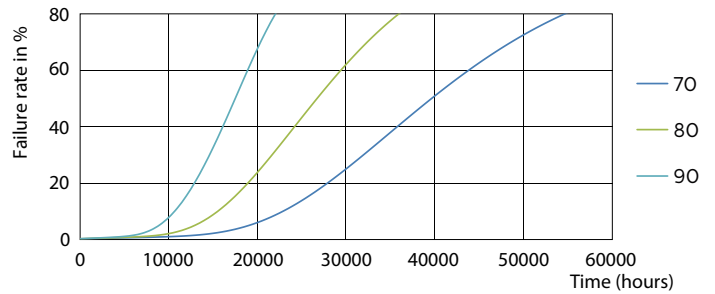
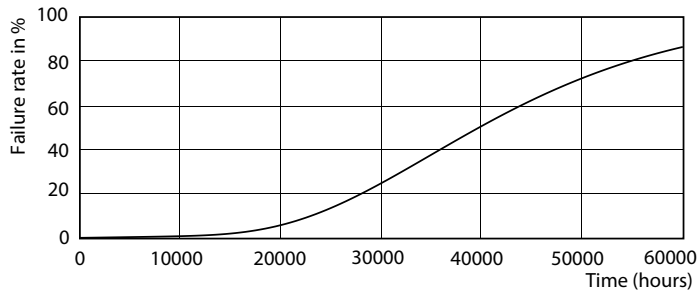

LEDtube PLC 100mm 9W G24D-3 830 950lm

LEDtube PLC 100mm 9W G24D-3 830 950lm

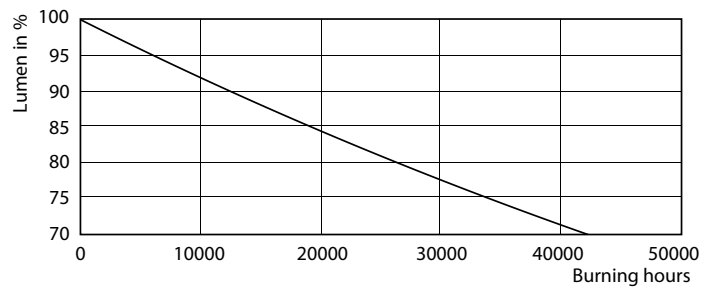
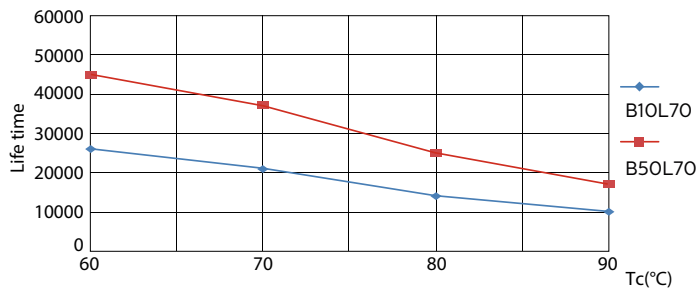

LEDtube PLC 100mm 9W G24D-3 830 950lm

LEDtube PLC 100mm 9W G24D-3 830 950lm

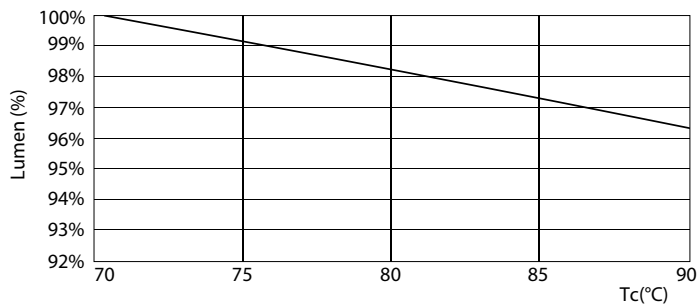

LEDtube PLC 100mm 9W G24D-3 830 950lm

