



# MASTER LEDspot ExpertColor LV

## MASTER LED ExpertColor LED MR16 ExpertColor 7.2-50W 927 24D

MASTER LEDspot LV ExpertColor creates a warm and comfortable ambience for hospitality venues, homes and restaurants. It creates such an ambience with superior lighting that has a customised spectrum, high CRI and deep dimming feature. The result? A beautiful lighting experience. What's more, the innovative, trimless lens design will suit almost any interior decor with its clean and neat look. In addition, you can take advantage of the full ExpertColor family, which also includes LEDspot MV and LEDspot Par lamps.

### Product data

General Information		Colour consistency	
Cap base	GU5.3 [ GU5.3]	Colour consistency	<3
Nominal lifetime (nom.)	40000 h	Colour Rendering Index,horiz (Nom)	97
Switching cycle	50000X	LLMF at end of nominal lifetime (nom.)	70 %
Technical type	7.2-50W	<b>Operating and Electrical</b>	
<b>Light Technical</b>		Power (Rated) (Nom)	7.2 W
Colour Code	927	Lamp current (nom.)	800 mA
Technical Beam Angle (Nom)	24°	Wattage equivalent	50 W
Lamp Luminous Flux 25°C EL (Nom)	450 lm	Starting time (nom.)	0.5 s
Lamp Luminous Flux (Nom)	450 lm	Warm-up time to 60% light (nom.)	1 s
Luminous intensity (nom.)	2200 cd	Power factor (nom.)	0.7
Colour Designation	Warm white (WW)	Voltage (Nom)	12 V
Rated beam angle	24°	<b>Temperature</b>	
Colour Temperature, horizontal (Nom)	2700 K	T-Case maximum (nom.)	92 °C
Lamp Luminous Efficacy EM (Nom)	62.50 lm/W		

# MASTER LEDspot ExpertColor LV

## Controls and Dimming

Dimmable	Yes
----------	-----

## Approval and Application

Energy-saving product	Yes
Suitable for accent lighting	Yes

## Product Data

Full product code	871869657177400
Order product name	MASTER LED ExpertColor LED MR16 ExpertColor 7.2-50W 927 24D

EAN/UPC – product	8718696571774
Order code	929001242208
Local Code	MEC450LMR1624D
Numerator – quantity per pack	1
Numerator – packs per outer box	10
Material no. (12NC)	929001242208
Net weight (piece)	0.034 kg

## Dimensional drawing

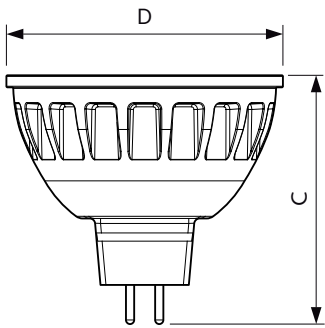

MR16 12V 7.2-50W 420lm 24D 2700K GU5.3 D

Product	D	C
MASTER LED ExpertColor LED MR16 ExpertColor 7.2-50W 927 24D	51 mm	46 mm

## Photometric data

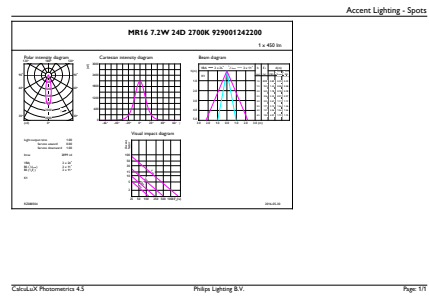
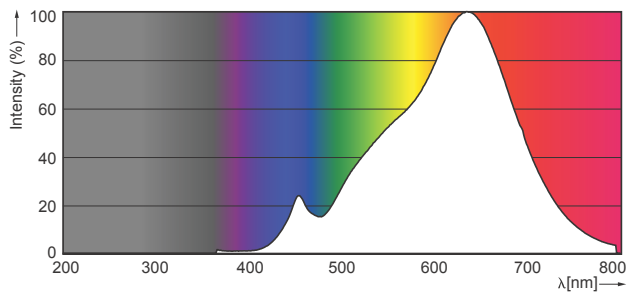

MAS LED ExpertColor 7.2-50W MR16 GU5.3 927 24D

# MASTER LEDspot ExpertColor LV

## Photometric data

