



MASTER LEDspot ExpertColor LV

MASTER LED ExpertColor LED MR16 ExpertColor 7.2-50W 940 24D

MASTER LEDspot LV ExpertColor creates a warm and comfortable ambience for hospitality venues, homes and restaurants. It creates such an ambience with superior lighting that has a customised spectrum, high CRI and deep dimming feature. The result? A beautiful lighting experience. What's more, the innovative, trimless lens design will suit almost any interior decor with its clean and neat look. In addition, you can take advantage of the full ExpertColor family, which also includes LEDspot MV and LEDspot Par lamps.

Product data

General Information	
Cap base	GU5.3 [GU5.3]
Nominal lifetime (nom.)	40000 h
Switching cycle	50000X
Technical type	7.2-50W
Light Technical	
Colour Code	940 [CCT of 4,000 K]
Technical Beam Angle (Nom)	24°
Lamp Luminous Flux 25°C EL (Nom)	480 lm
Lamp Luminous Flux (Nom)	480 lm
Luminous intensity (nom.)	2400 cd
Colour Designation	Cool White (CW)
Rated beam angle	24°
Colour Temperature, horizontal (Nom)	4000 K
Lamp Luminous Efficacy EM (Nom)	66.67 lm/W

Colour consistency	<3
Colour Rendering Index,horiz (Nom)	97
LLMF at end of nominal lifetime (nom.)	70 %
Operating and Electrical	
Power (Rated) (Nom)	7.2 W
Lamp current (nom.)	800 mA
Wattage equivalent	50 W
Starting time (nom.)	0.5 s
Warm-up time to 60% light (nom.)	1 s
Power factor (nom.)	0.7
Voltage (Nom)	12 V
Temperature	
T-Case maximum (nom.)	92 °C

MASTER LEDspot ExpertColor LV

Controls and Dimming

Dimmable Yes

Approval and Application

Energy-saving product Yes

Suitable for accent lighting Yes

Product Data

Full product code 871869657181100
 Order product name MASTER LED ExpertColor LED MR16
 ExpertColor 7.2-50W 940 24D

EAN/UPC – product 8718696571811
 Order code 929001242408
 Local Code MEC510LMR1624D
 Numerator – quantity per pack 1
 Numerator – packs per outer box 10
 Material no. (12NC) 929001242408
 Net weight (piece) 0.034 kg

Dimensional drawing

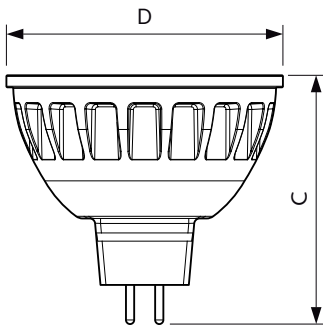

MR16 12V 7.2-50W 420lm 24D 4000K GU5.3 D

Product	D	C
MASTER LED ExpertColor LED MR16 ExpertColor 7.2-50W 940 24D	51 mm	46 mm

Photometric data

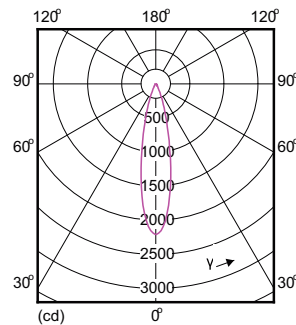
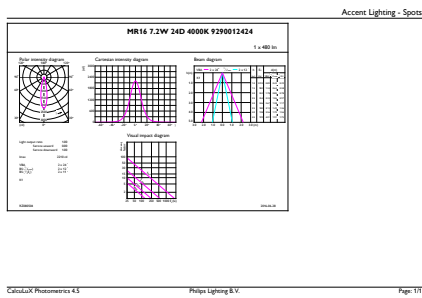

MAS LED ExpertColor 7.2-50W MR16 GU5.3 940 24D

MASTER LEDspot ExpertColor LV

Photometric data

