



# PL-S

## 5PL-S/LED/13H/835/IF5/P/2P 20/1

Philips LED PL-S lamps make the transition to LED from CFL lamps as simple as replacing a lamp. The InstantFit (UL Type A) 2-pin PL-S LED lamps are available in a wide array of color temperatures. They quickly and effectively replace 13W 2-pin compact fluorescent PL-S lamps.

### Product data

General Information	
Cap-Base	GX23 [ GX23]
RoHS mark	RoHS mark
Nominal Lifetime (Nom)	50000 h
Switching Cycle	50000X
B50L70	50000 h
Light Technical	
Color Code	835 [ CCT of 3500K]
Beam Angle (Nom)	120 °
Luminous Flux (Nom)	560 lm
Luminous Flux (Rated) (Nom)	560 lm
Rated Beam Angle	120 °
Correlated Color Temperature (Nom)	3500 K
Color Consistency	<6
Color Rendering Index (Nom)	82
LLMF At End Of Nominal Lifetime (Nom)	70 %
Operating and Electrical	
Input Frequency	50 to 60 Hz
Power (Rated) (Nom)	5 W
Lamp Current (Max)	50 mA
Lamp Current (Min)	15 mA

Starting Time (Nom)	0.5 s
Warm Up Time to 60% Light (Nom)	0.5 s
Power Factor (Nom)	0.9
Voltage (Nom)	120-277 V
Temperature	
T-Ambient (Max)	45 °C
T-Ambient (Min)	-20 °C
T-Storage (Max)	65 °C
T-Storage (Min)	-40 °C
T-Case Maximum (Nom)	75 °C
Controls and Dimming	
Dimmable	No
Mechanical and Housing	
Height	15.8 mm
Approval and Application	
Energy Saving Product	Yes
Approval Marks	UL certificate RoHS compliance

# PL-S

## Product Data

Order product name	5PL-S/LED/13H/835/IF5/P/2P 20/1
EAN/UPC - Product	046677529574
Order code	929001863004
Numerator - Quantity Per Pack	1

Numerator - Packs per outer box	20
Material Nr. (12NC)	929001863004
Net Weight (Piece)	0.043 kg

## Dimensional drawing

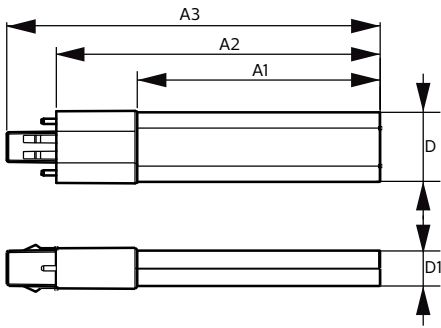

PLED PLS 120-277V 5-13W 580lm 3500K GX23

Product	D	D1	A1	A2	A3
5PL-S/LED/13H/835/IF5/P/2P 20/1	31.1 mm	15.8 mm	108 mm	144 mm	166 mm

## Photometric data

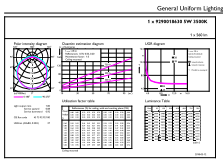

Manufacturer: Philips Lighting B.V. Age: 11

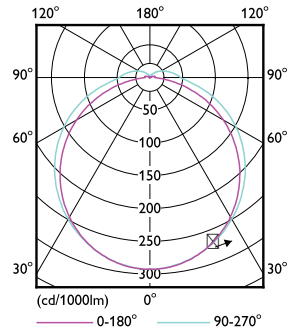

LEDtube PLS 5W GX23 835 2P 12D ND

LEDtube PLS 5W GX23 827 2P 12D ND

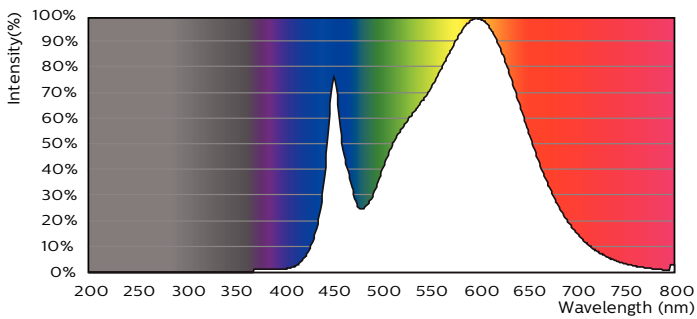

LEDtube PLS 5W GX23 835 2P 12D ND

Lifetime

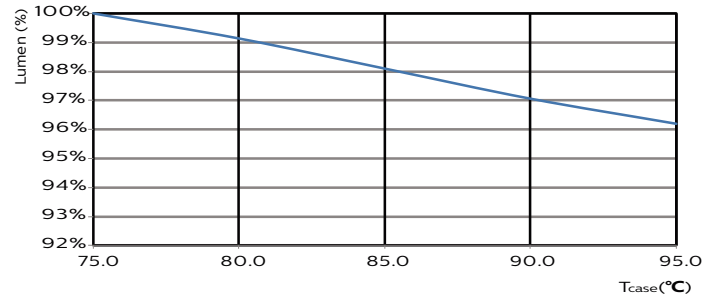
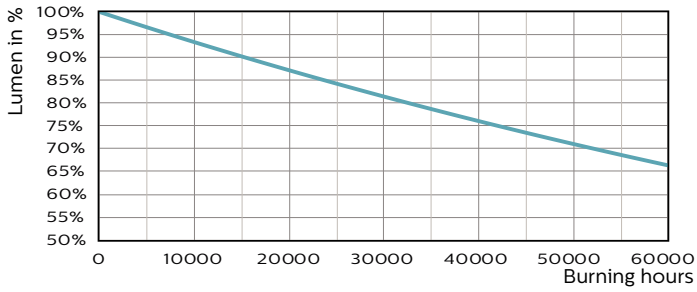

LEDtube PLS 5W GX23 827 2P 12D ND

LEDtube PLS 5W GX23 827 2P 12D ND

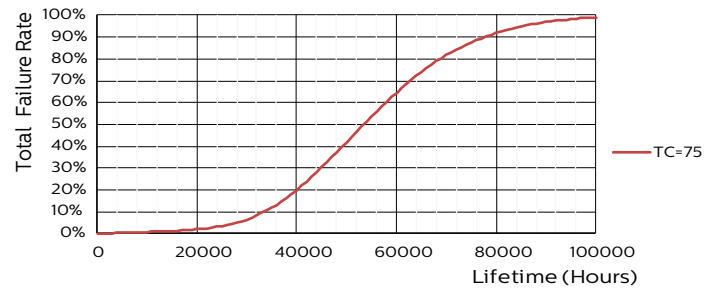
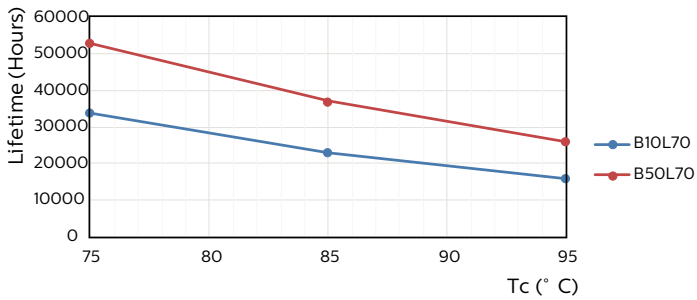

LEDtube PLS 5W GX23 827 2P 12D ND

LEDtube PLS 5W GX23 827 2P 12D ND

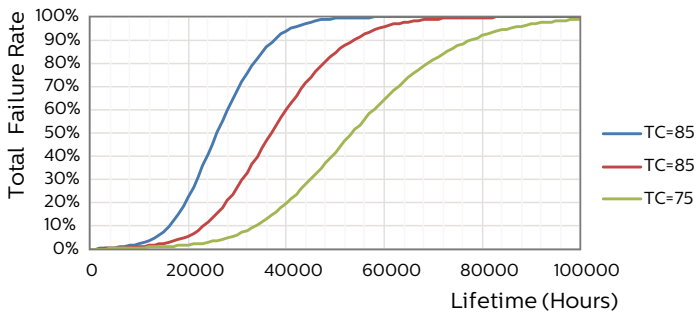

LEDtube PLS 5W GX23 827 2P 12D ND

